

# ÍNDICE

## ÍNDICE

Indice	1
Filetes	2
Angulos	3
Barras solidas	6
Platinas	7
Canales	8
Portafelpas	12
Tubos circulares	13
Tubos con aletas	16
Tubos ovalados	16
Tubos rectangulares	17
Tubos cuadrados	22
Tubo multifuncional	23
Pasamanos y Barandas	24
Cantoneiras y terrazos	25
Tees	26
Celosias	26
Puertas de ducha	27
Rieles de closet	28
Angulos de rieles	29
Rieles	30
Sistema nova	31
Zócalos de pared	31
Zócalos H	32
Contramarcos	33
Avisos luminosos	35
Serie 3825 - Ventana corrediza económica	36
Serie 3831 - Ventana proyectante económica	38
Serie 42 - Ventana proyectante	40
Serie 35 - Puerta y/o ventana batiente	42
Serie 3142 - Ventana corrediza superior	44
Serie 3642 - Mampara corrediza superior	46
Acrílicos	48
Polycarbonato	49

# FILETES

**ALN-1167**



**JV-0235**



**0221**

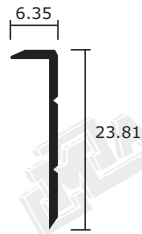

**0220**

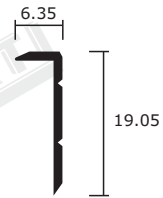

**ALN-1165**

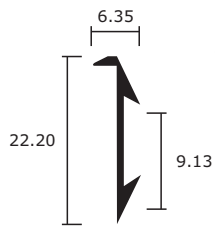

**0319**

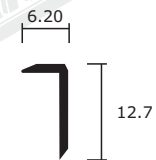

**0304**



**ALN-1168**



# ÁNGULOS

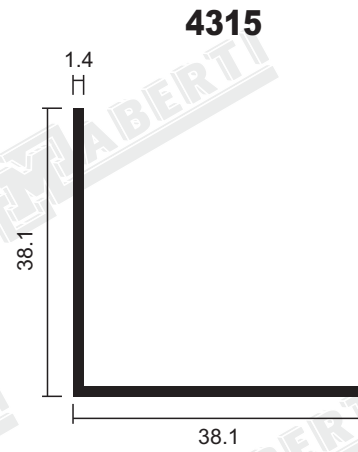
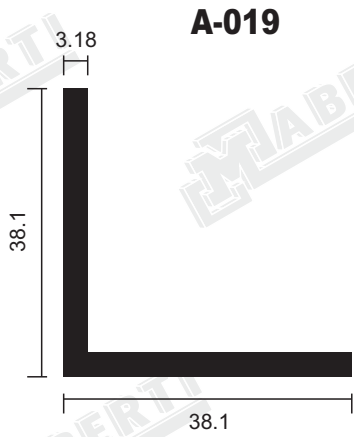
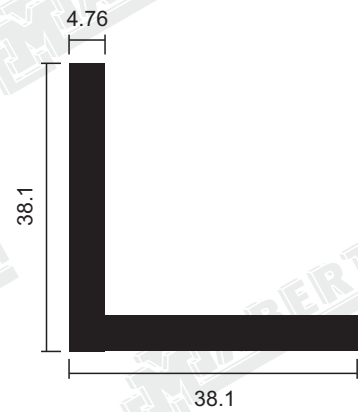
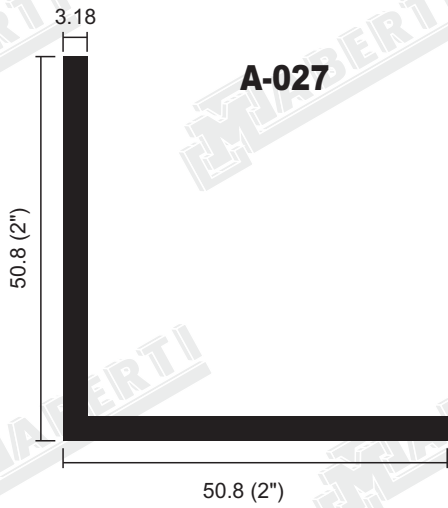
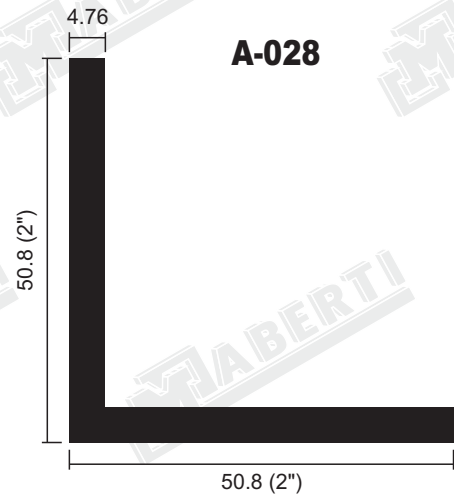
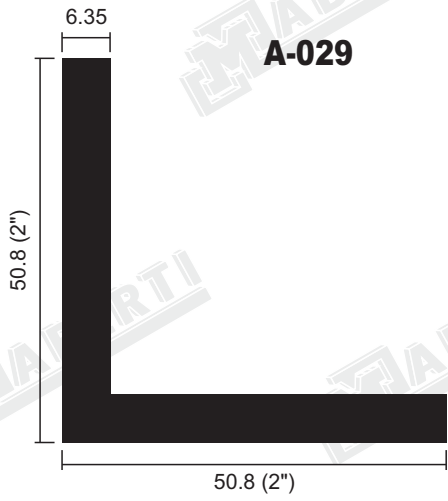

# ÁNGULOS

**4316**

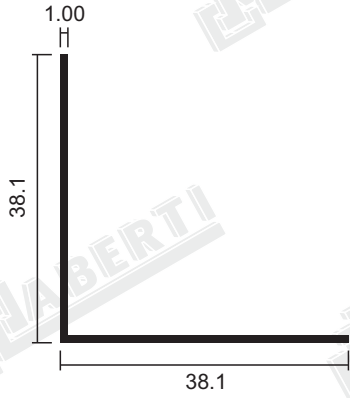

**ALN-1209**

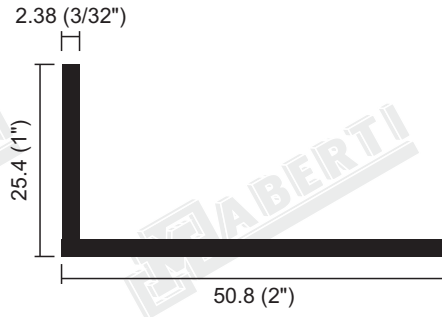

**A-011**

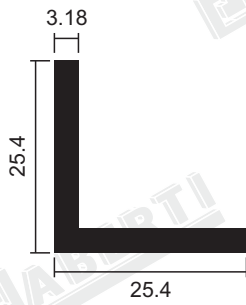

**A-010**

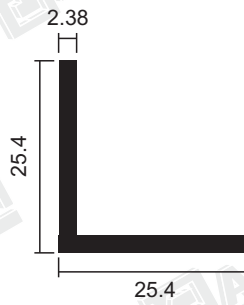

**A-009**

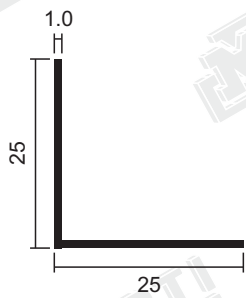

**4110**

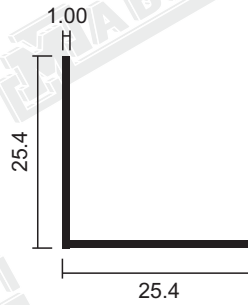



# ÁNGULOS

**4011**



**4104**

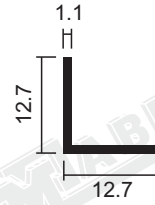

**A-005**

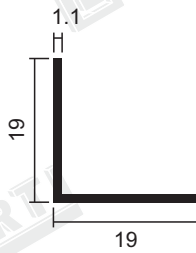

**4107**

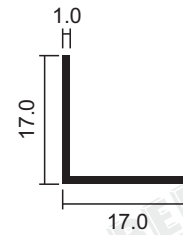

**4103**

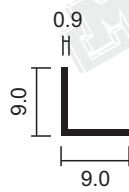

**4105**

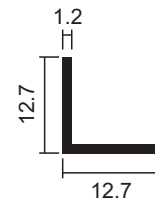

# BARRAS SÓLIDAS

**R-008**

15.87 (5/8")



**1044**

12.70 (1/2")



**R-005**

9.52 (3/8")



**1020**

7.93 (5/16")



**1012**

6.35 (1/4")



**1004**

5.55 (7/32")



**1002**

4.76 (3/16")



# PLATINAS

**1650**

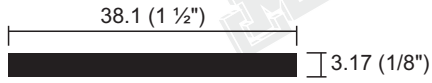

**1670**

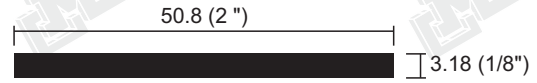

**1820**

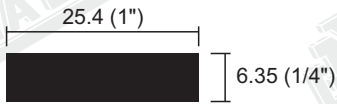

**P-029**

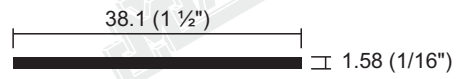

**P-017**



**1640**



**P-013**

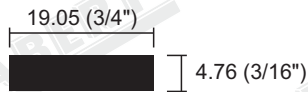

**P-016**

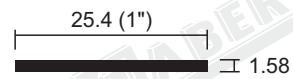

**1570**

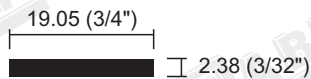

**1630**

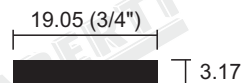

**1620**

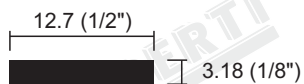

**P-001**

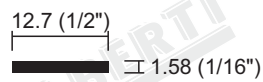

**1520**

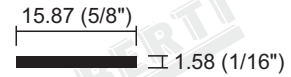

# CANALES

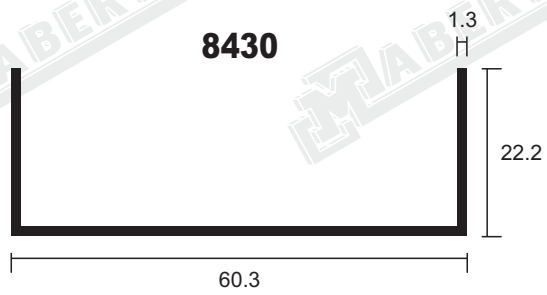
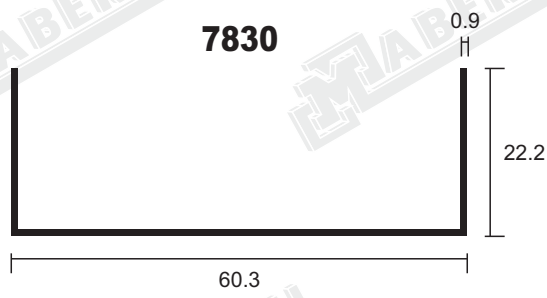
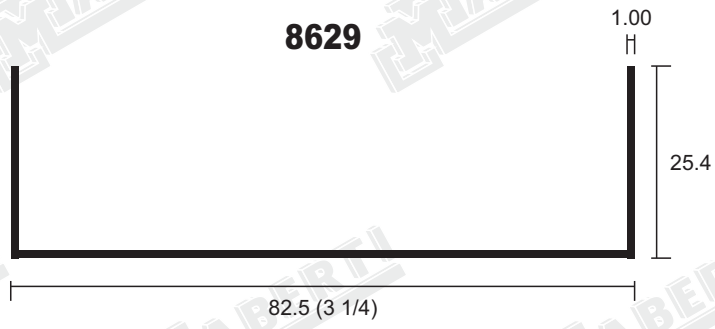

# CANALES

**3019**

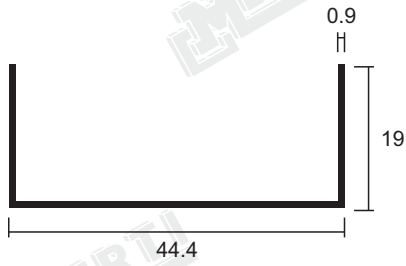

**U-085**

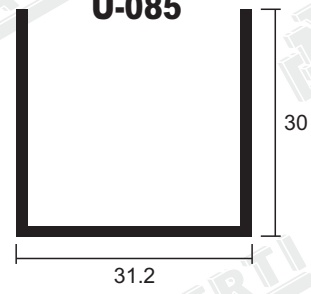

**ALN-1160**

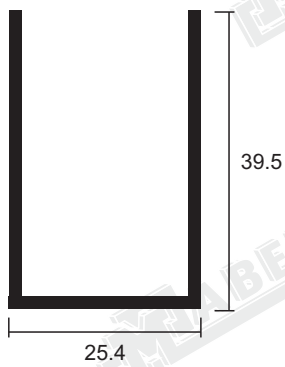

**3009**

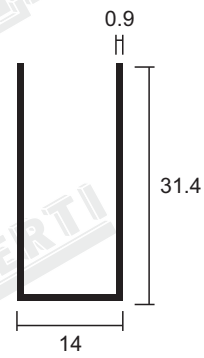

**3315**

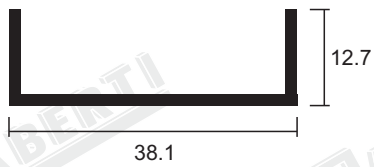

**8330**

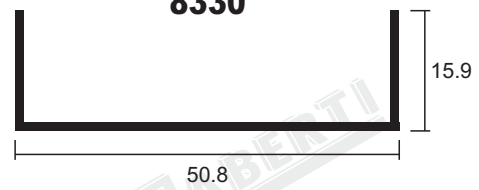

**U-102**

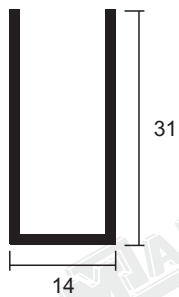

**3007**

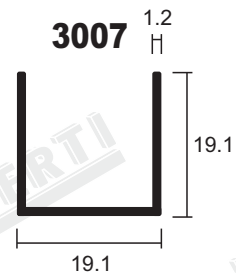

**3207 INTERMEDIO**

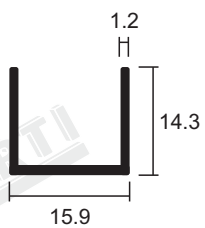

**3207 ECO**

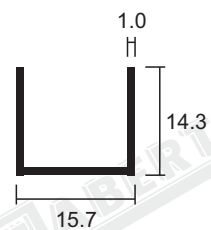

# CANALES

**3190**

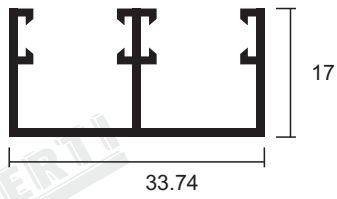

**3185**

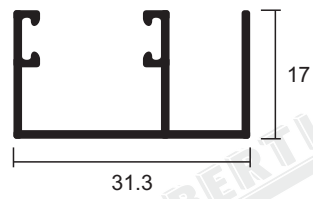

**3007 - 2/FELPAS**

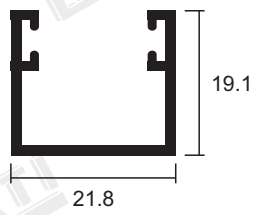

**3007 - 1/FELPA**

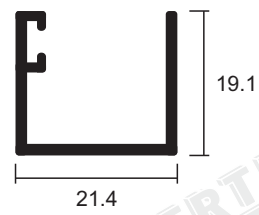

**3207 - C/P 8**

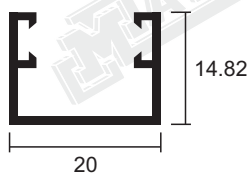

**3207 - C/P 6**

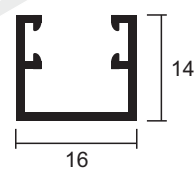

# CANALES

**7955**

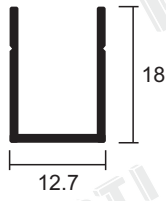

**U 13**

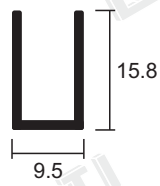

**3003 ECO**

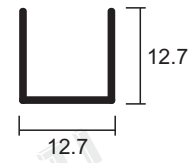

**ALN-943**

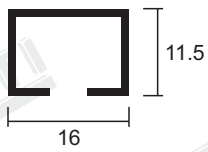

**ALN-7005**

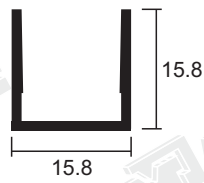

**ALN-7004**

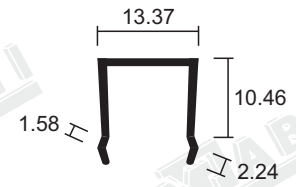

**3061**

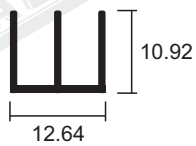

**7001**

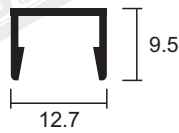

**7003**

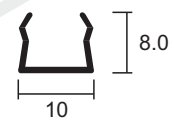

**3206**

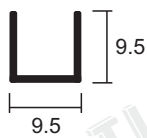

**3062**



**ALN-925**

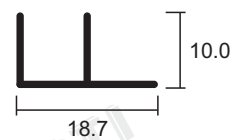

# PORTAFELPAS

**8015**

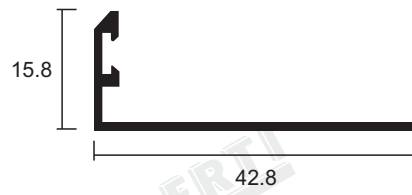

**8503 INTERMEDIO**

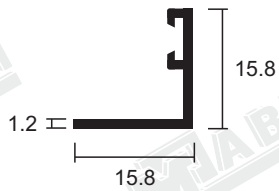

**8503 ECO**

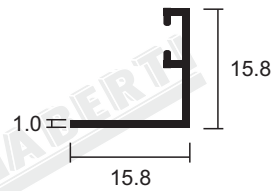

**8116**

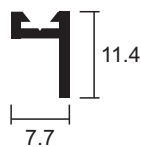

**8115**

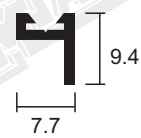

**8115 C/2 ALETAS**

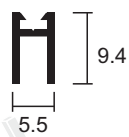

**8114**

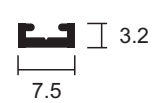



# TUBOS CIRCULARES

**5680**

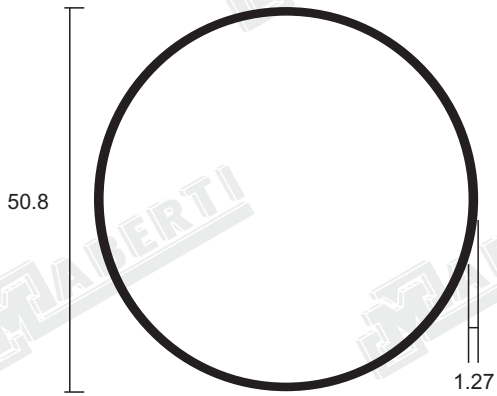

**5662**

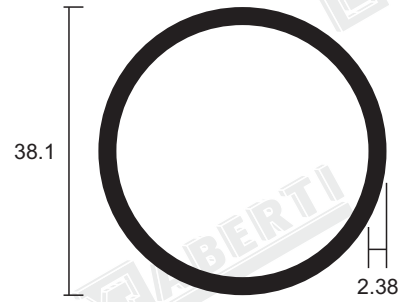

**TC-031**

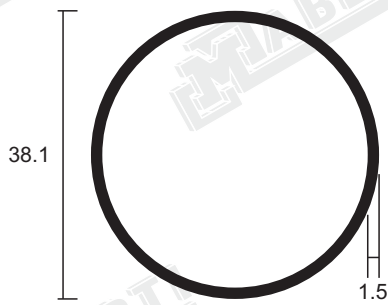

**TC-027**

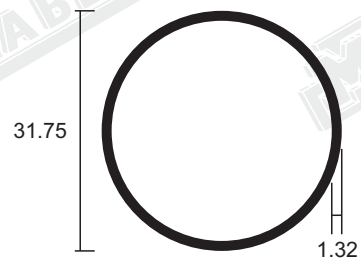

**5609 GRUESO**



**5609 INTERMEDIO**

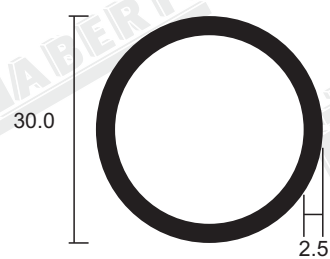

# TUBOS CIRCULARES

**5609 ECO**

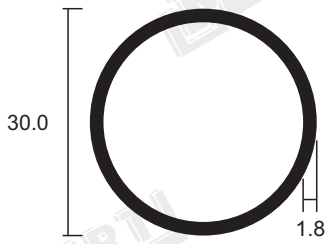

**5584**

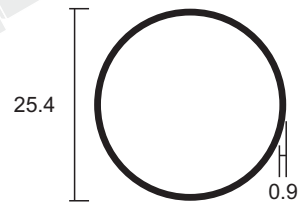

**5584 GRUESO**

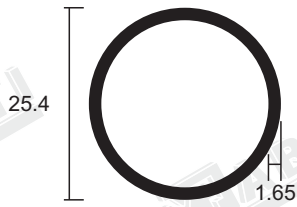

**TC-018**

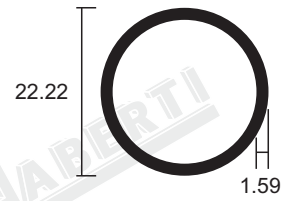

**TC-020**

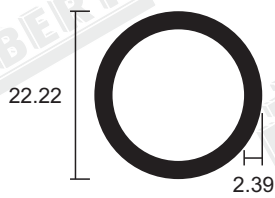

**5559**

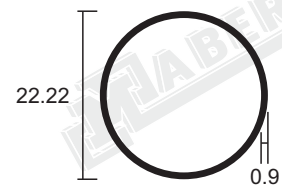

**TCE-017**

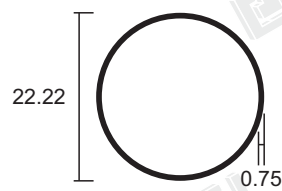

# TUBOS CIRCULARES

**TC-016**



**5541**



**5524**



**5520**



**5525**



**5504**



## TUBOS CON ALETAS

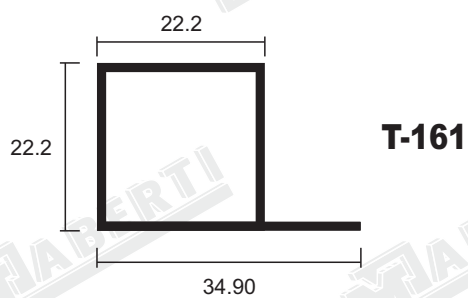
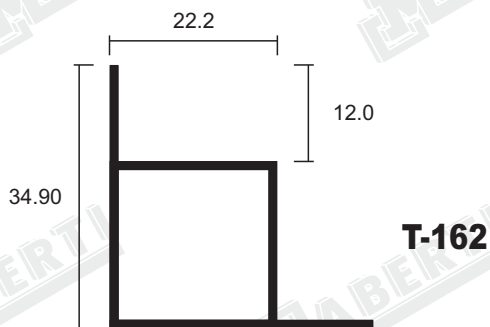
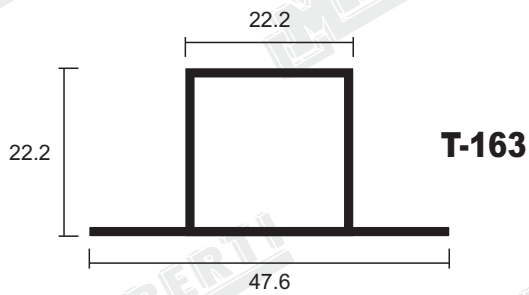
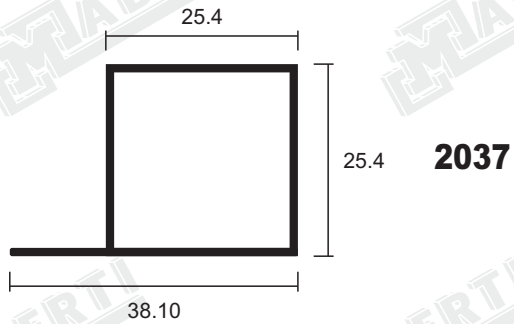
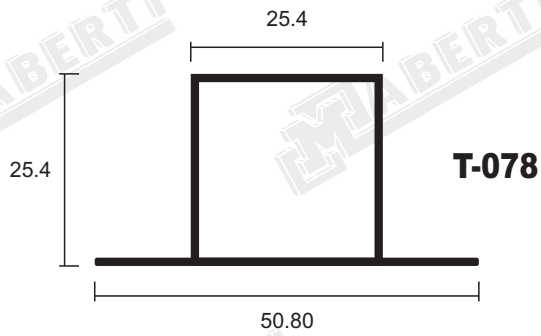

## TUBOS OVALADOS

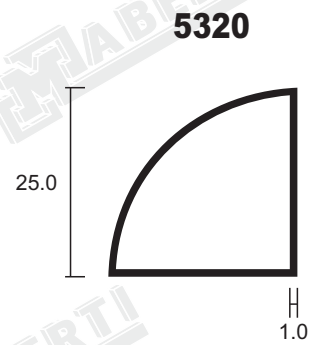
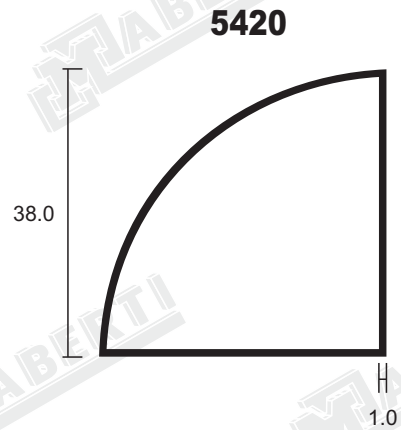

# TUBOS RECTANGULARES

**ALN-5144**

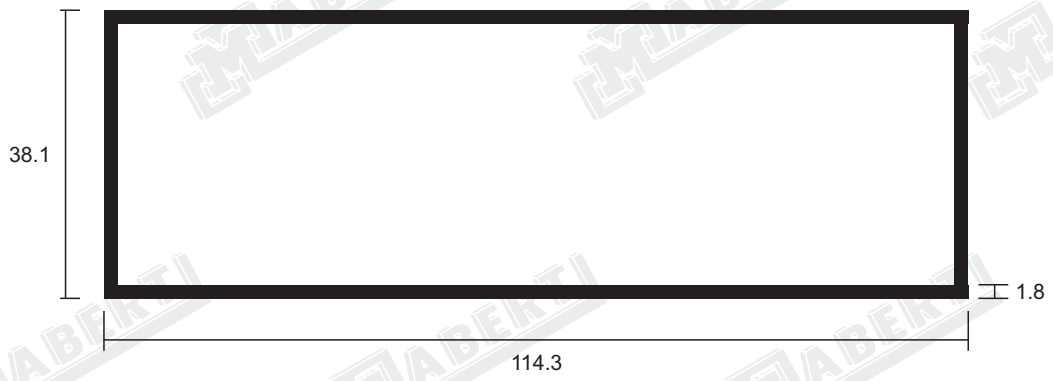

**T-081**

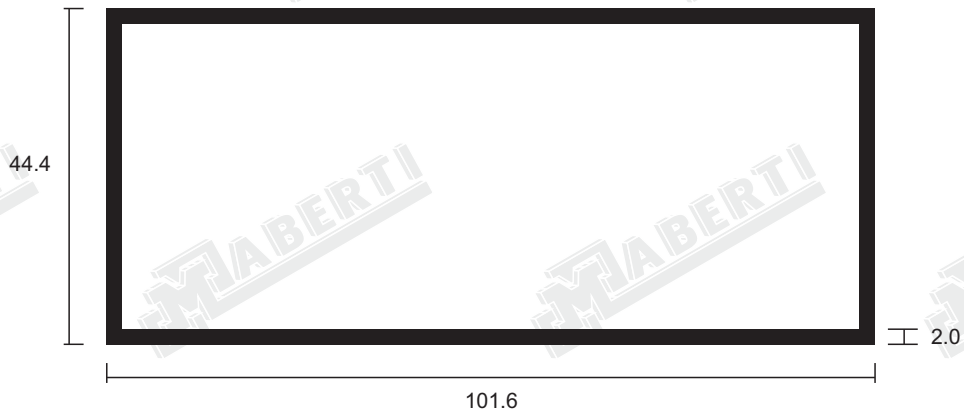

**T-101**

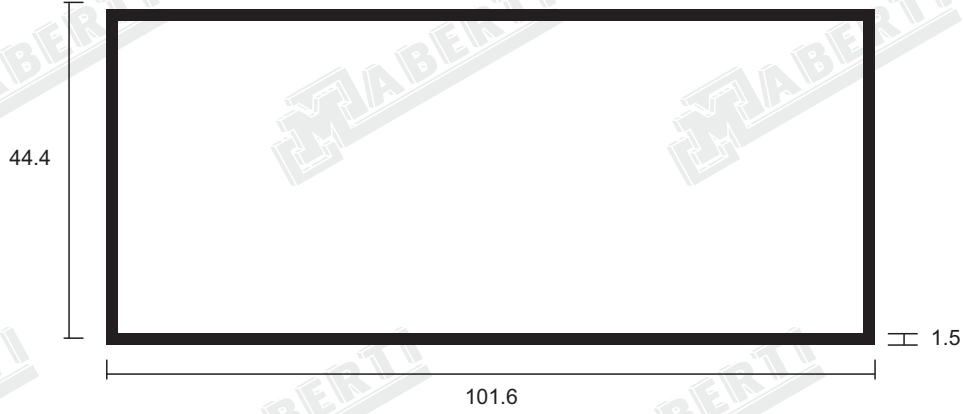

**5142**

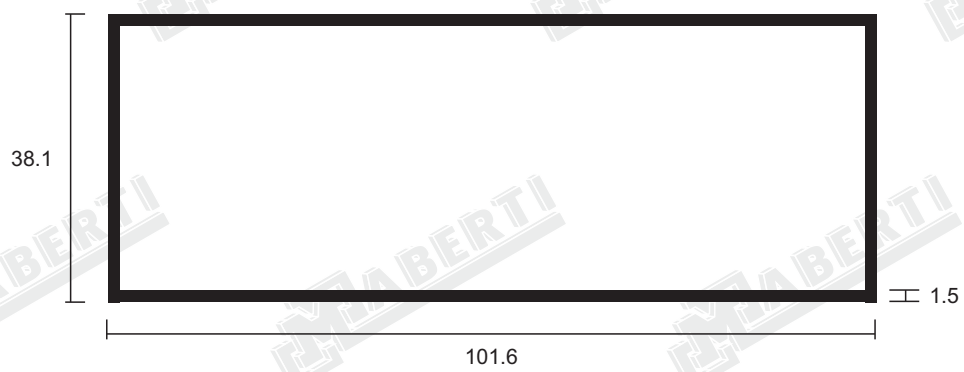

## TUBOS RECTANGULARES

**5230**

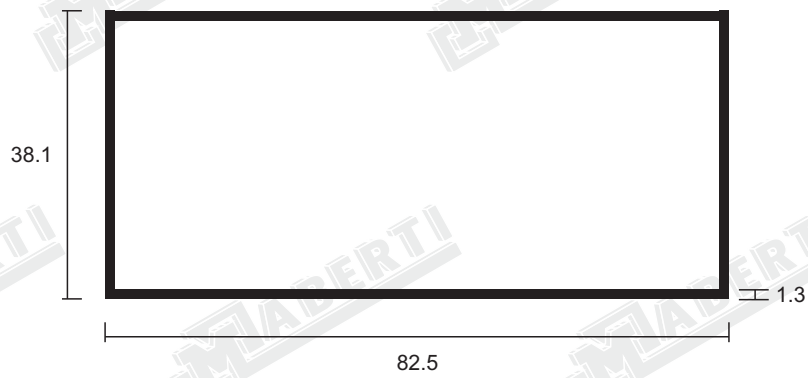

**5229**

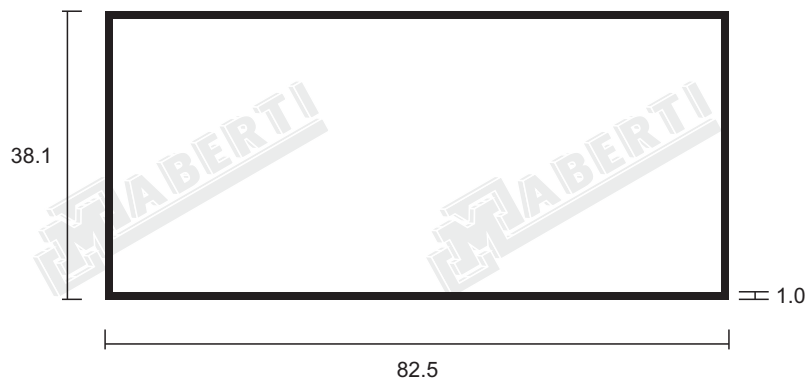

**8651**

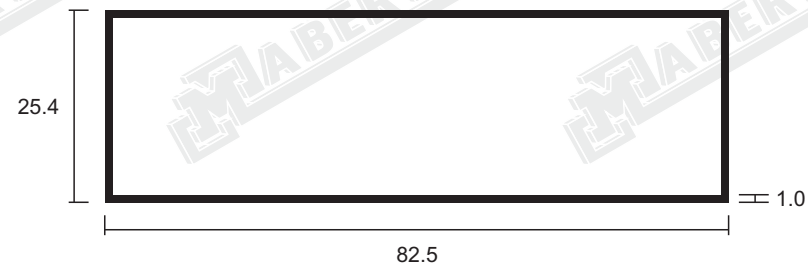

**T-148**

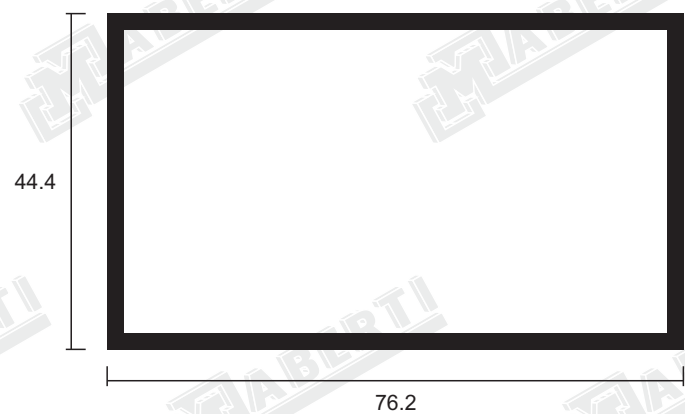

# TUBOS RECTANGULARES

**T-071**

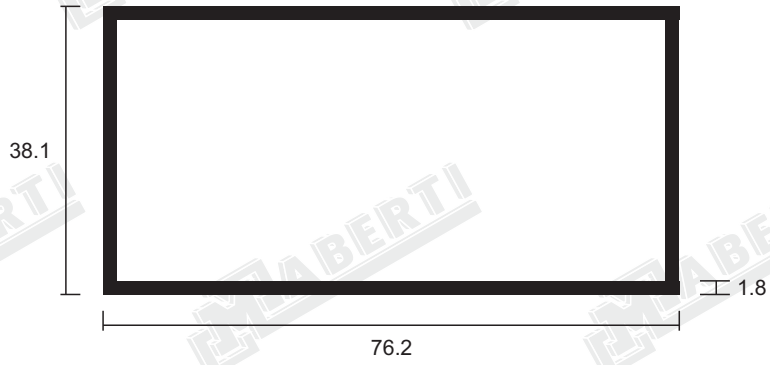

**T-129**

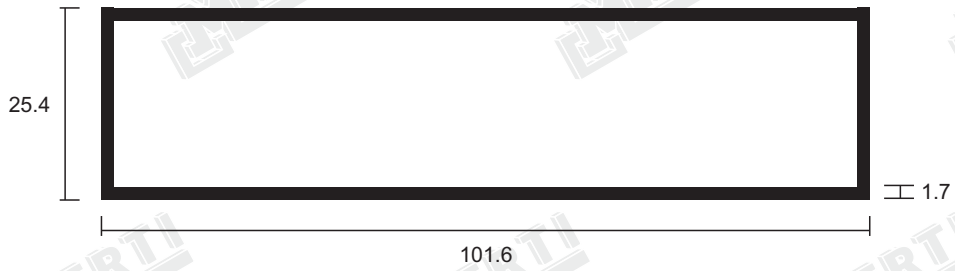

**T-137**

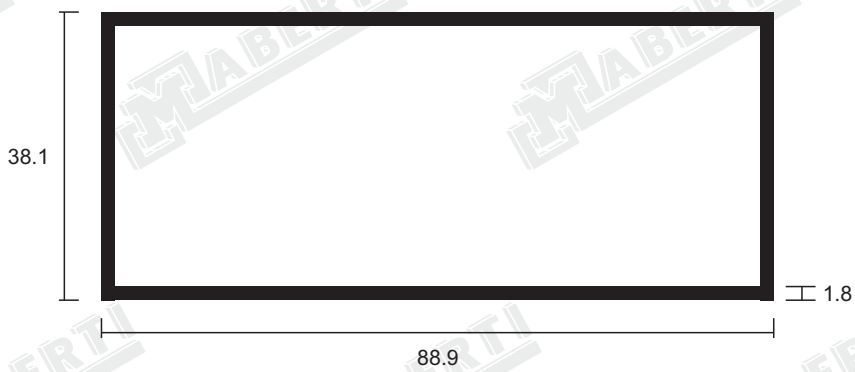

# TUBOS RECTANGULARES

**8650**

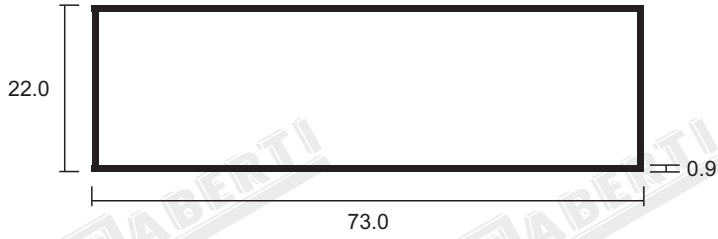

**5220**

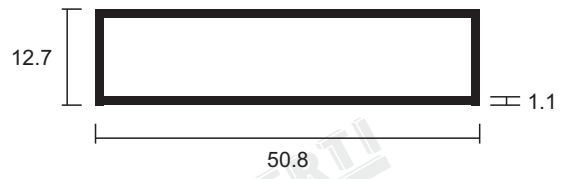

**5221**

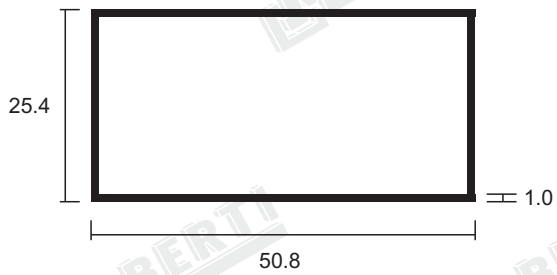

**5221-GRUESO**

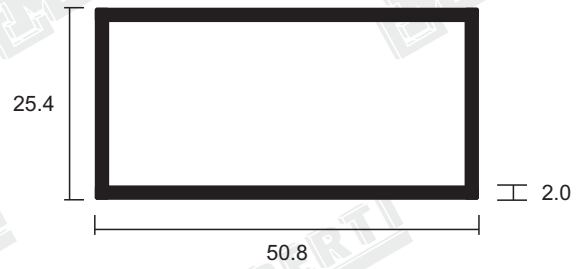

**7851**

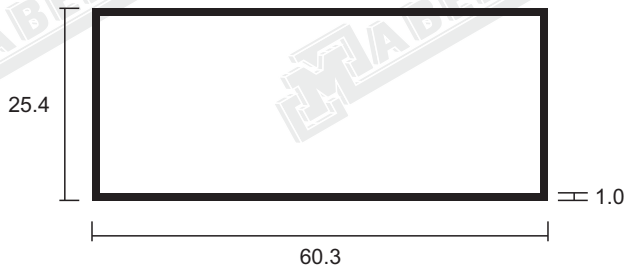

**7851-GRUESO**

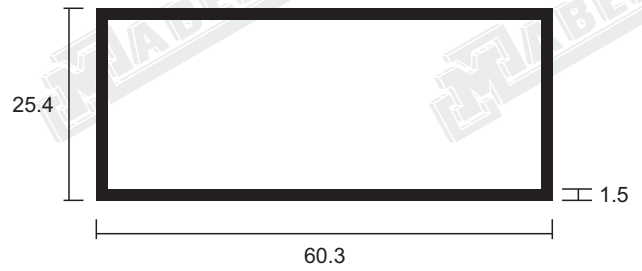



# TUBOS RECTANGULARES

**T-094**

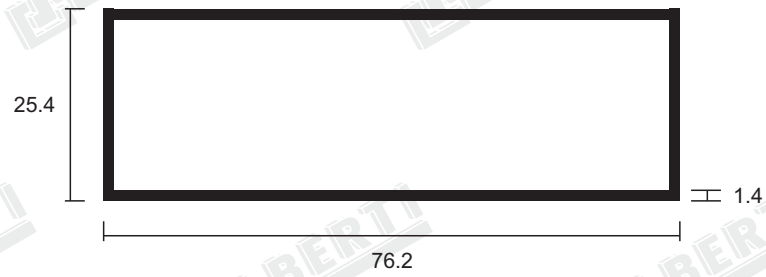

**5123-GRUESO**

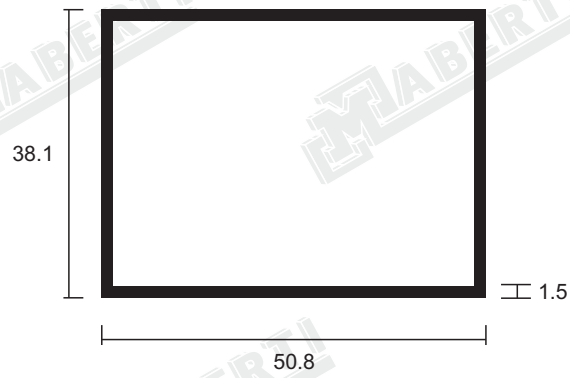

**5123-NORMAL**

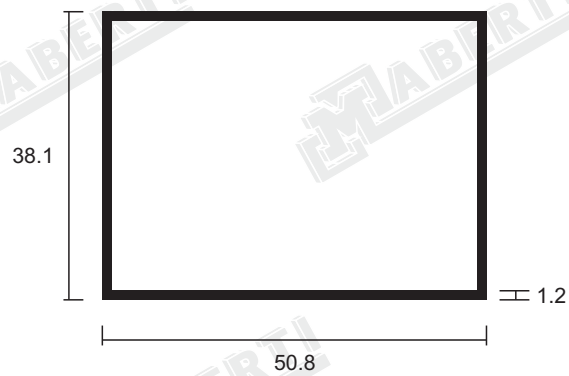

# TUBOS CUADRADOS

**5124**

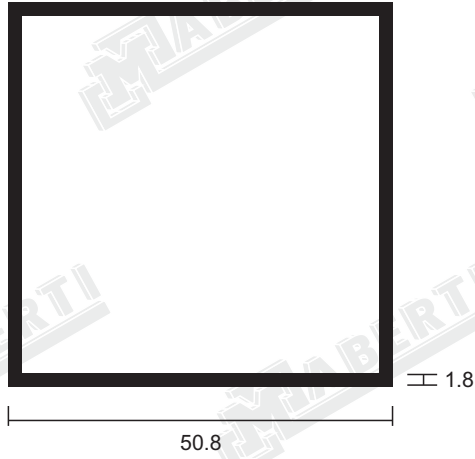

**5213**

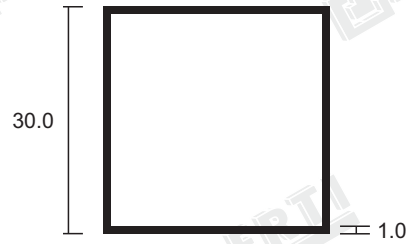

**5416**

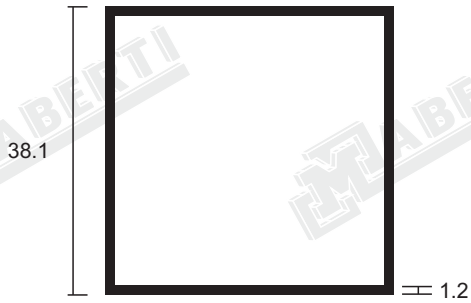

**5415**

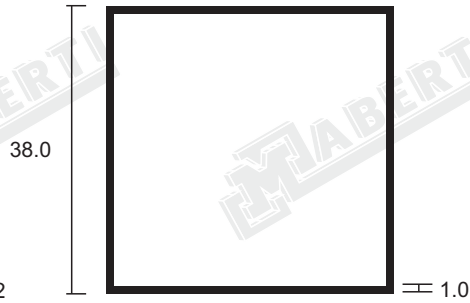

**5407**



**5310 GRUESO**

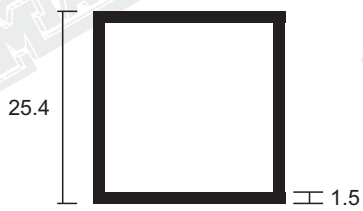

**5310**

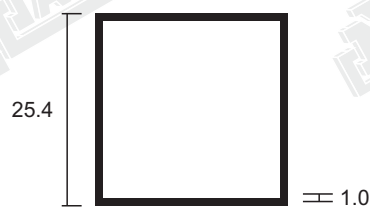

**5310 INTERMEDIO**

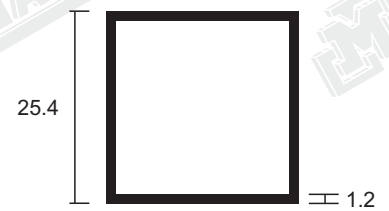

**5217-GRUESO**

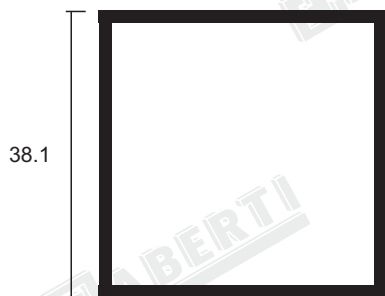

**5217-NORMAL**

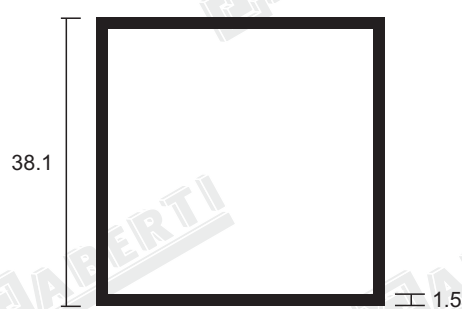

**LIM-029**

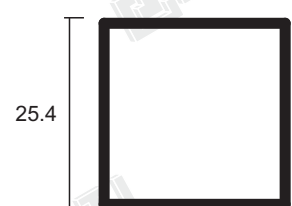

# TUBO MULTIFUNCIONAL

**5282**

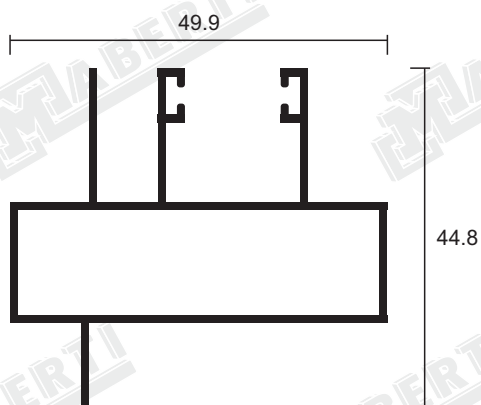

**5284**

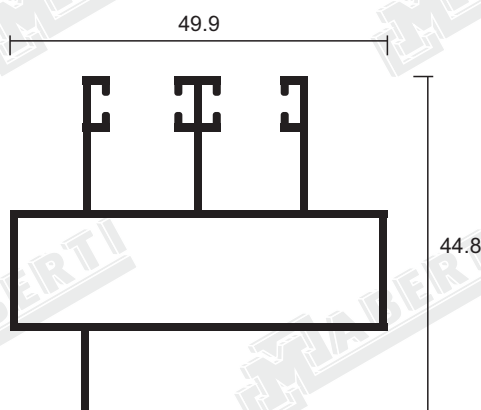

# PASAMANOS Y BARANDAS

**2602**

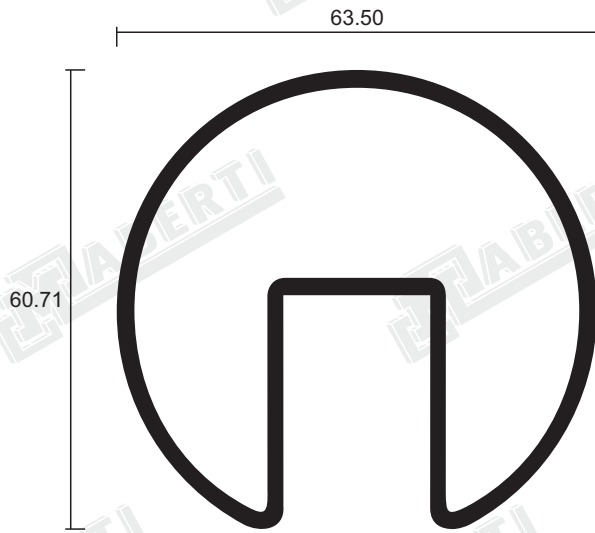

**LIM-018**

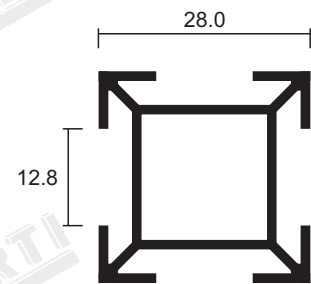

**2410**

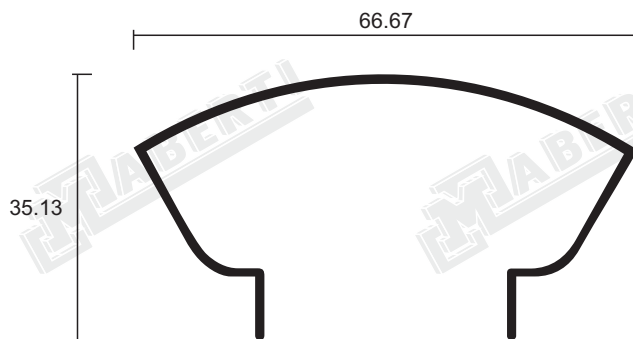

**2431**

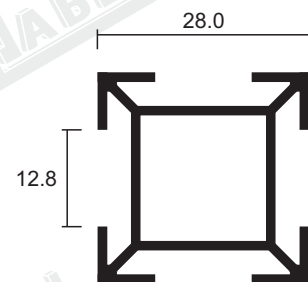

**2490**

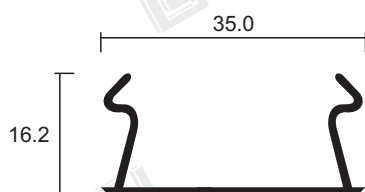

# CANTONERAS Y TERRAZOS

**2552-ECO**

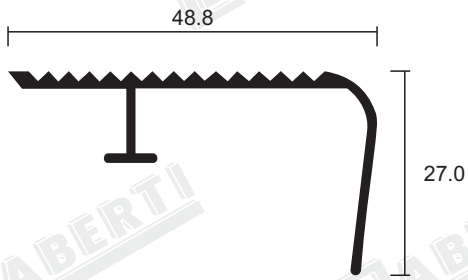

**2542-ECO**

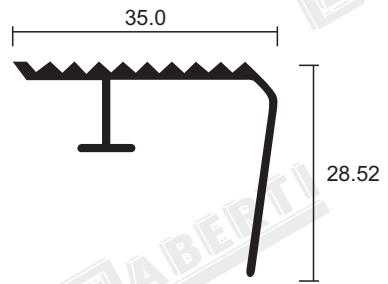

**2551-ECO**

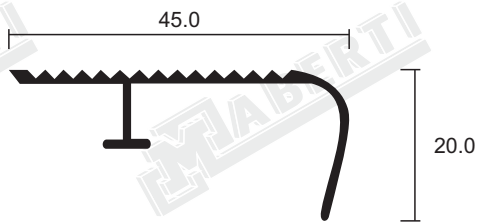

**2541-ECO**

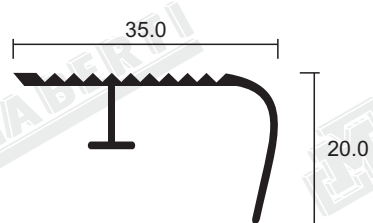

**2550**

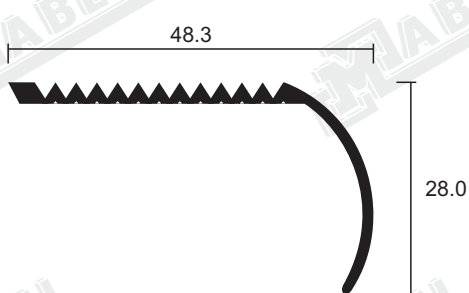

**2540**

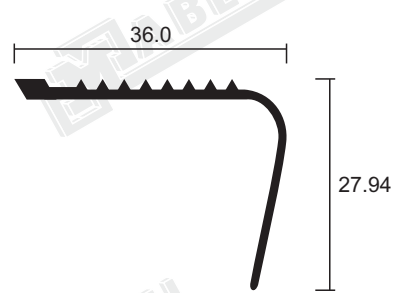

**LIM-025**

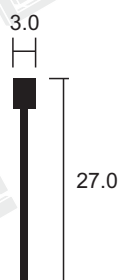

**2535**

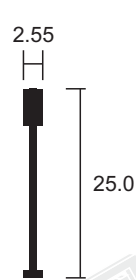

# TEES

**D-010**

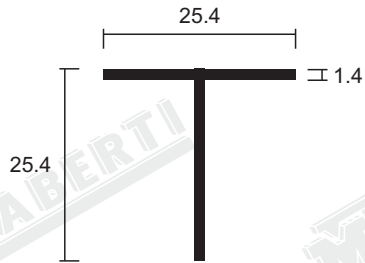

**6110**

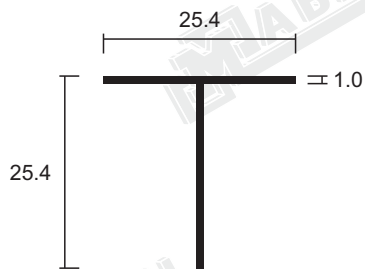

**6108**

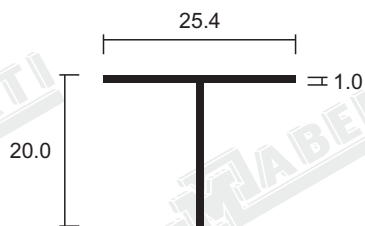

# CELOSIAS

**8521**

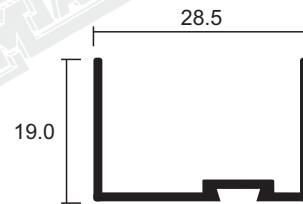

**8502**



# PUERTAS DE DUCHA

9301

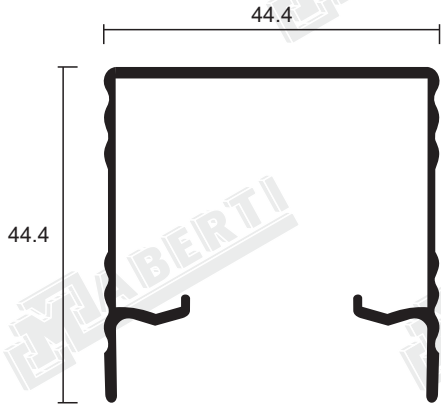

9302

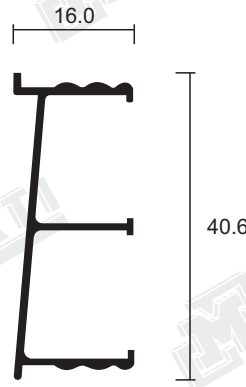

9303

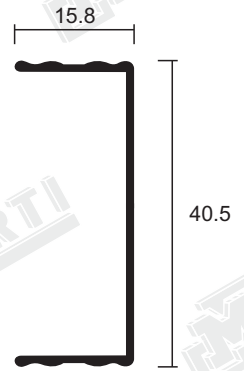

9306

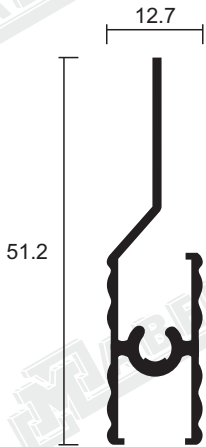

9305

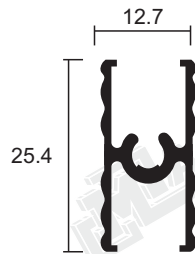

9304

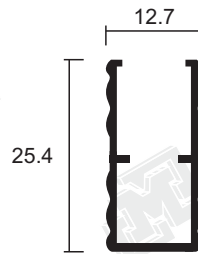

9307



9308

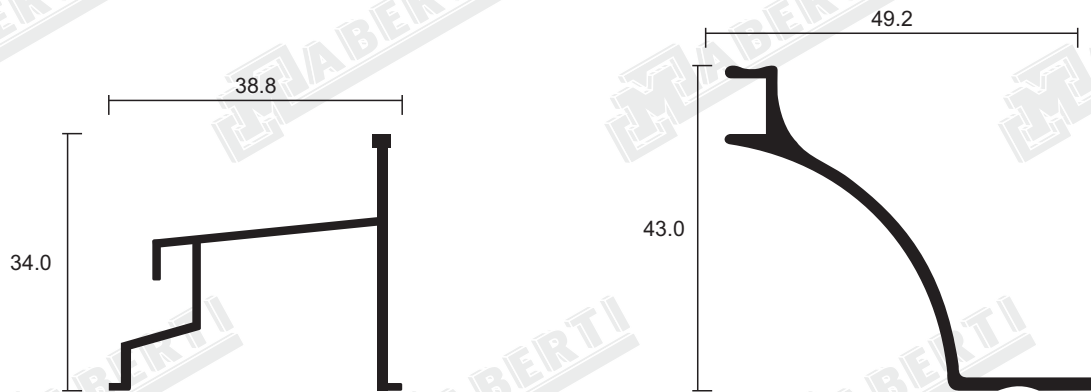

# RIELES DE CLOSET

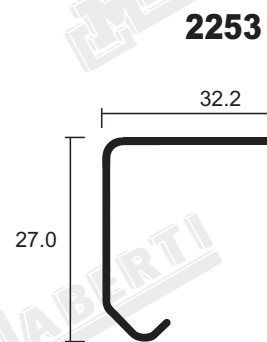
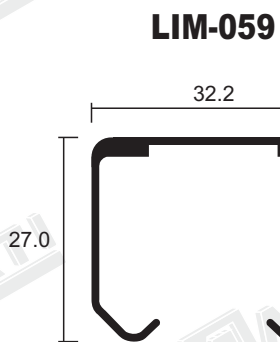
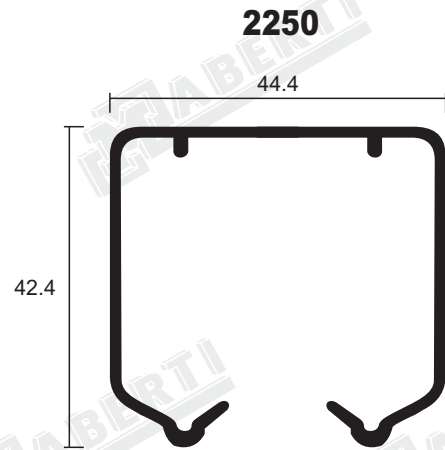
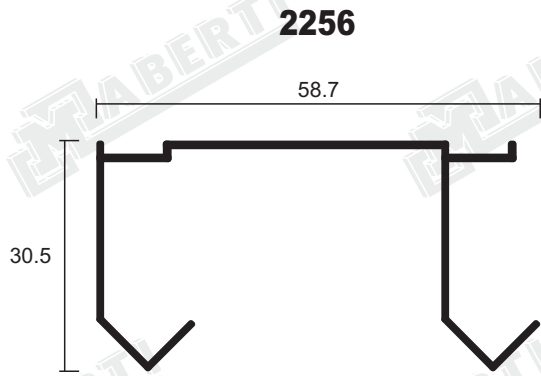



# ÁNGULOS DE RIELES

**LIM-046**

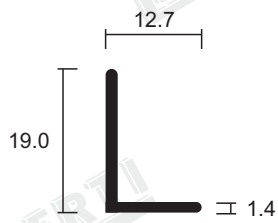

**8462**

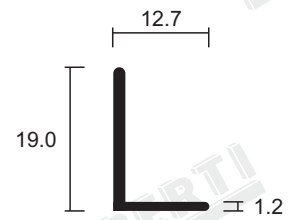

**8413-GRUESO**

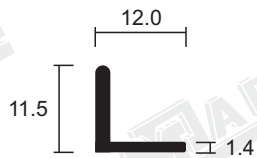

**8413**

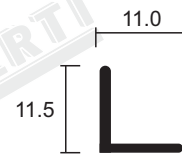

**8464**

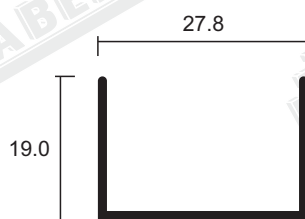

**8465**

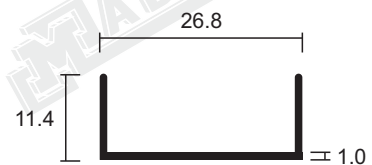

**8413-DOBLE**

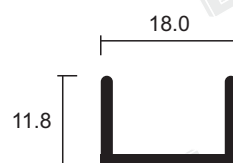

# RIELES

**2242**

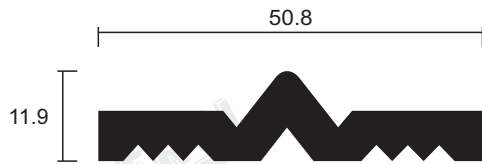

**2244-DOBLE RIEL**

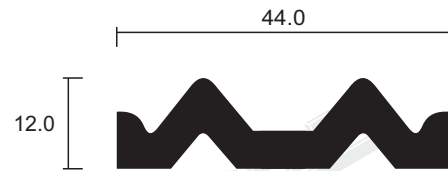

**ALN-1164**

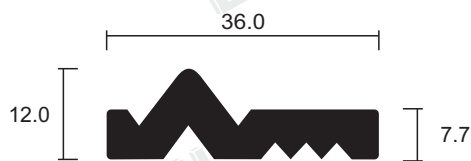

**2244**

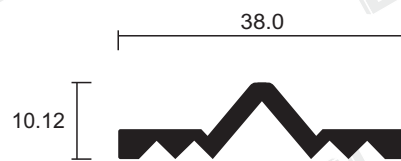

**2244-UNA ALETA**

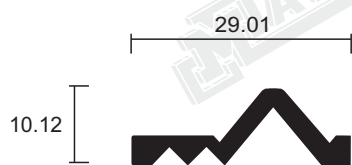

**2240**

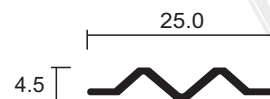

## SISTEMA NOVA

### LIM-021-8

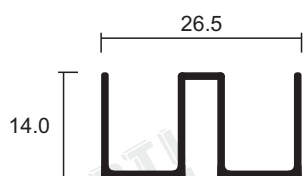

### 3182

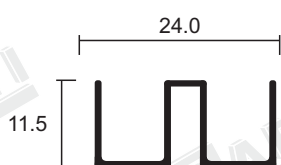

### 3183

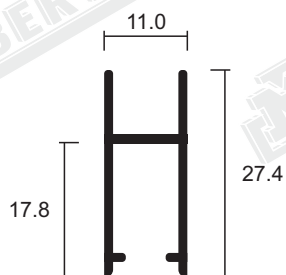

### 3181

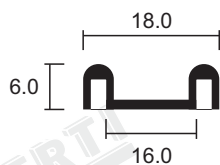

## ZÓCALOS DE PARED

### MIY-2102

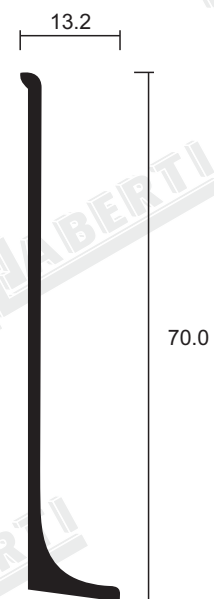

### MIY-2104

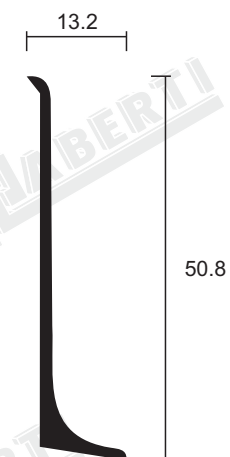

### ALN-1170

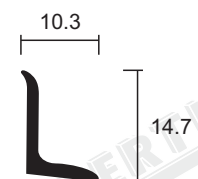

# ZÓCALOS H

**7903**



**7905**



**7906**



**7908**

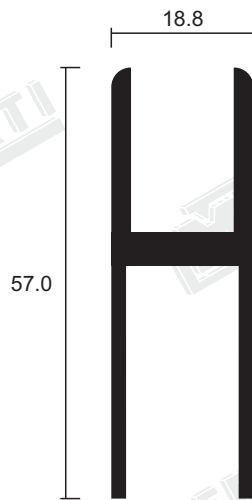

**9150**

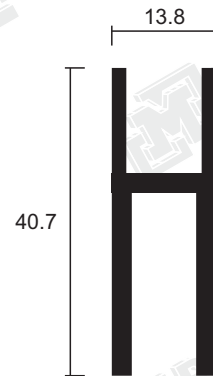

**LIM-075**

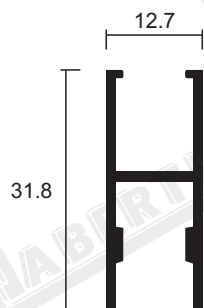

**8220-GRUESO**

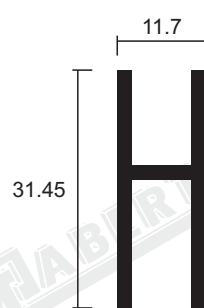

**8220**

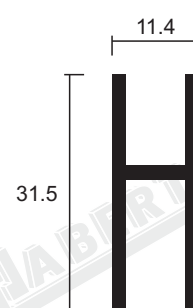

# CONTRAMARCOS

**8482-FAM**

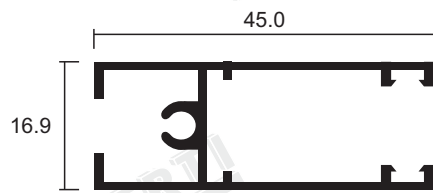

**8438**

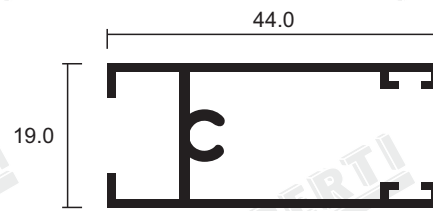

**8436**

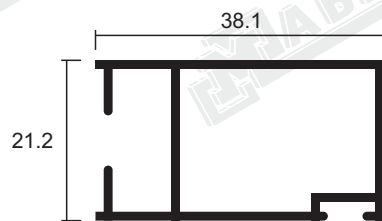

**8482-MET**

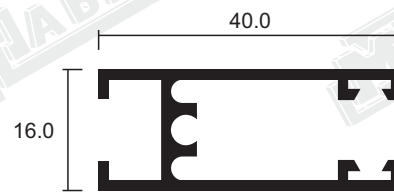

**8488**

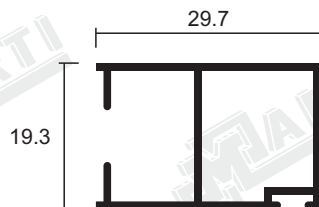

**8437**

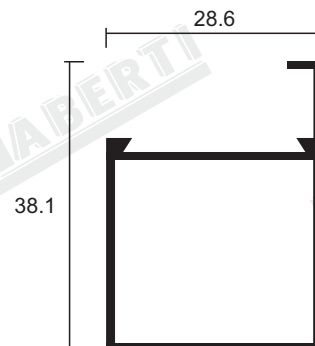

# CONTRAMARCOS

**7300**

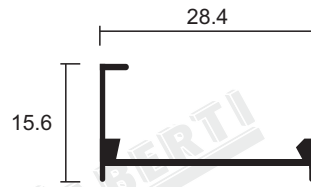

**LIM-004**

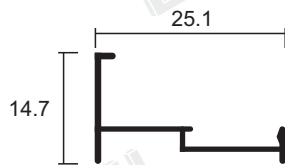

**7305**

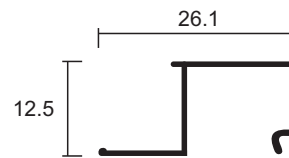

**ALN-1169**

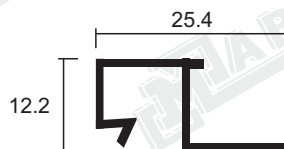

**LIM-005**

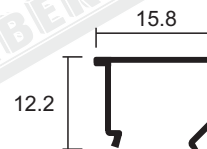

# AVISO LUMINOSO

9108

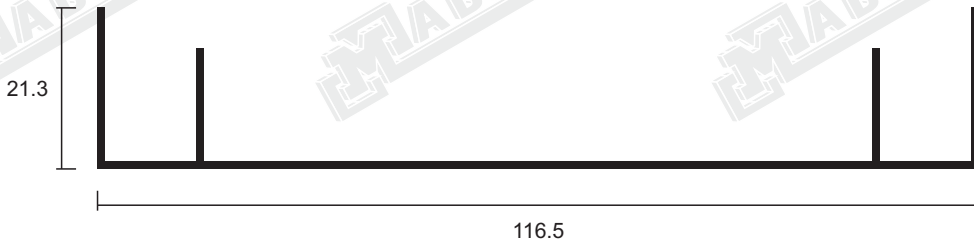

9008

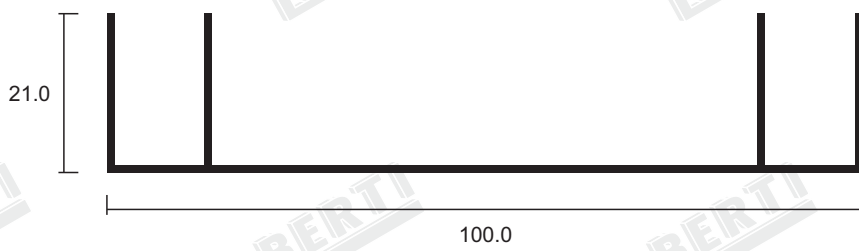

# SERIE 3825 - VENTANA CORREDIZA ECONÓMICA

## CORTE HORIZONTAL

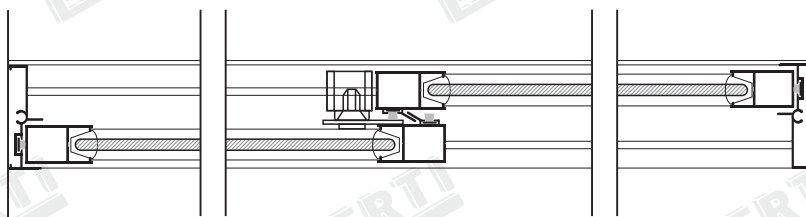

## CORTE VERTICAL

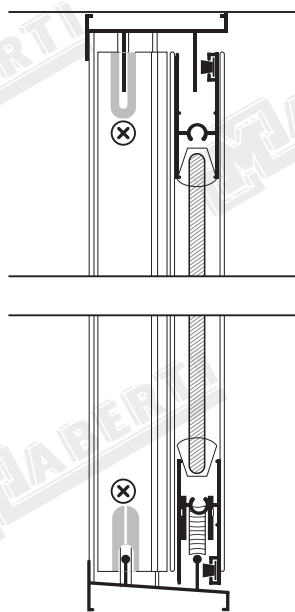

PERFIL											
CÓDIGO	ALN-709	ALN-710	ALN-711	ALN-712	ALN-713	ALN-714	ALN-715	ALN-716	ALN-738	ALN-740	ALN-741
USO	Sillar 1 riel	Piema doble vidrio	Jamba fija	Jamba movil	Enganche	Piema	Horiz. superior e interior movil	Horiz. superior e interior fijo	Sillar doble riel	Cabezal doble riel	Traslape adaptador



# SERIE 3825 - VENTANA CORREDIZA ECONÓMICA

**ALN-710**

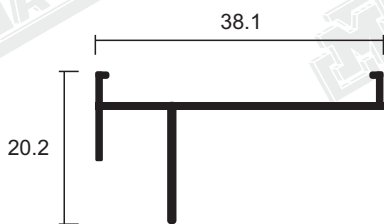

**ALN-709**

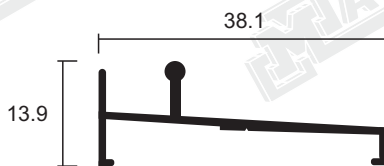

**ALN-740**

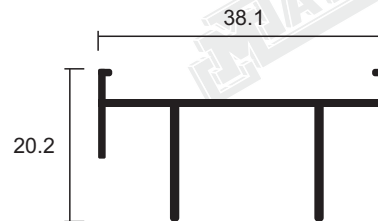

**ALN-738**

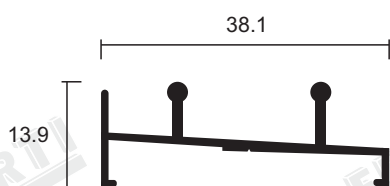

**ALN-711**

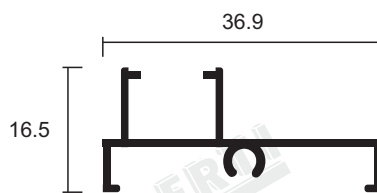

**ALN-714**

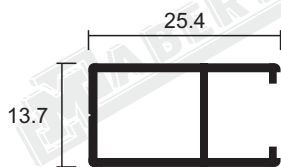

**ALN-712**

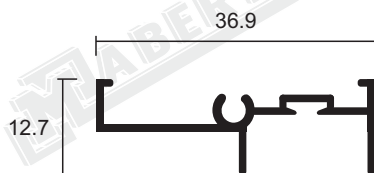

**ALN-713**

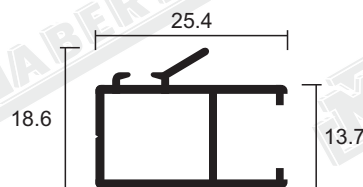

**ALN-715**

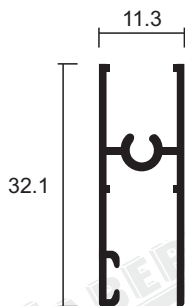

**ALN-716**

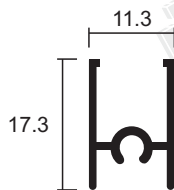

**ALN-741**

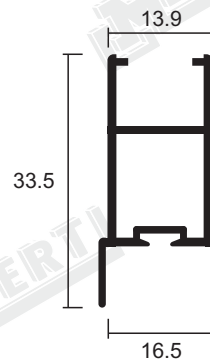

# SERIE 3831 - VENTANA PROYECTANTE ECONÓMICA

## CORTE HORIZONTAL

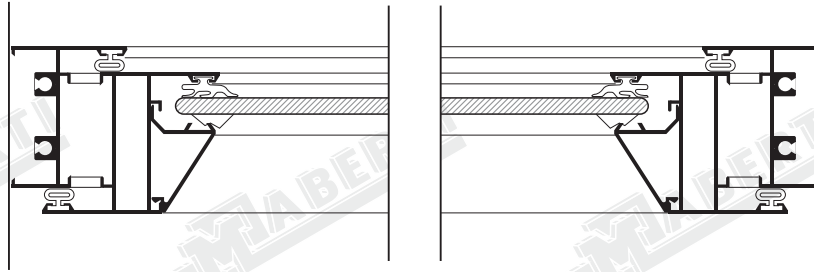

## CORTE VERTICAL

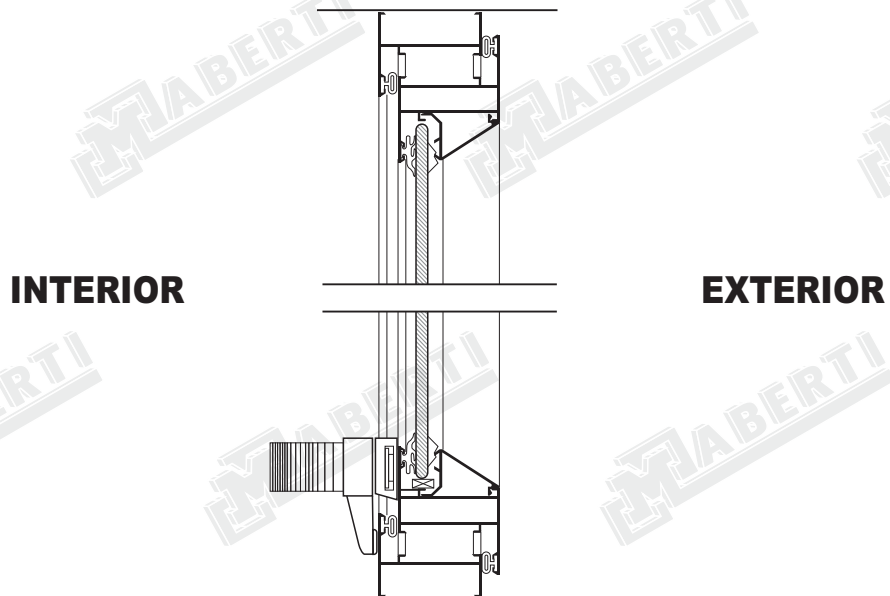

PERFIL											
CÓDIGO	ALN-173	ALN-174	ALN-176	ALN-177	ALN-292	ALN-395	ALN-414	ALN-416	ALN-435	ALN-481	ALN-483
USO	Marco	Marco	Marco nave	Junquillo	Divisor	Junquillo para vidrio de 6mm.	Junquillo para vidrio de 10mm.	Nave	Junquillo para vidrio de 10mm.	Junquillo para vidrio doble separador de 1/4"	Marco

# SERIE 3831 - VENTANA PROYECTANTE ECONÓMICA

**ALN-292**

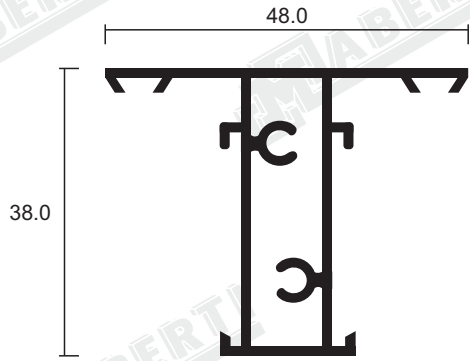

**ALN-176**

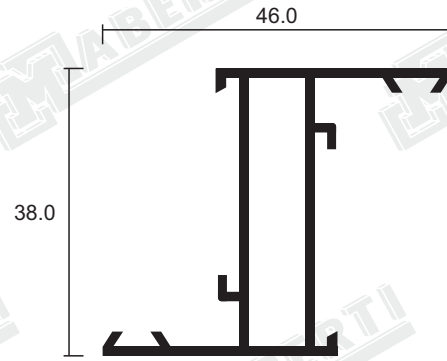

**ALN-416**

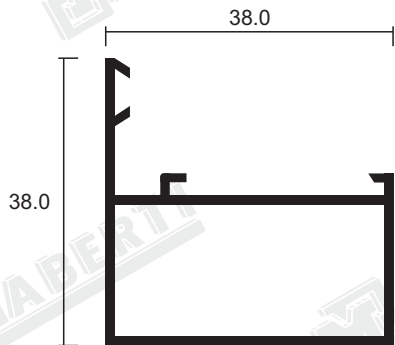

**ALN-173**

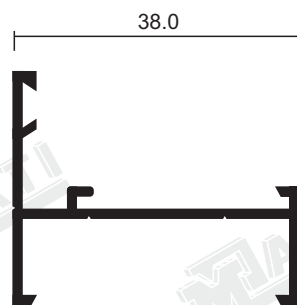

**ALN-174**

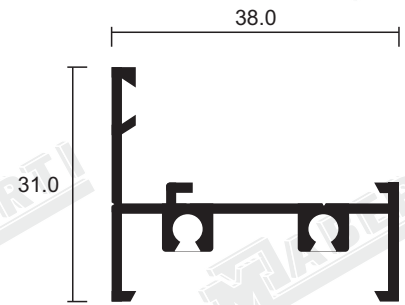

**ALN-483**

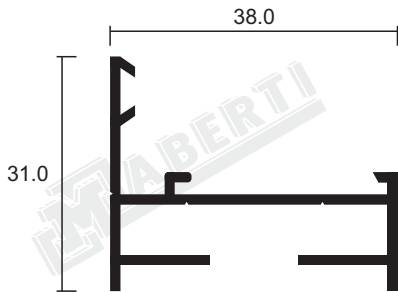

**ALN-175**

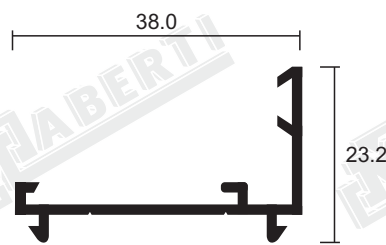

**ALNA-635**

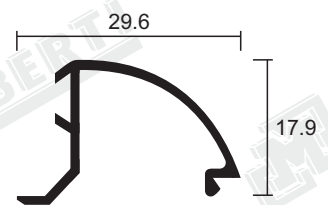

**ALN-177**

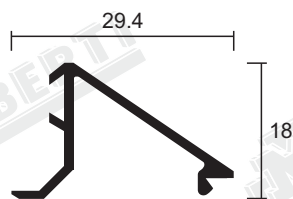

**ALN-395**

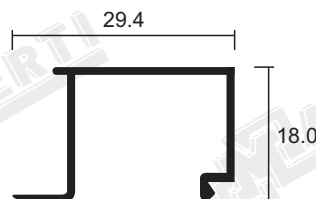

**ALN-435**

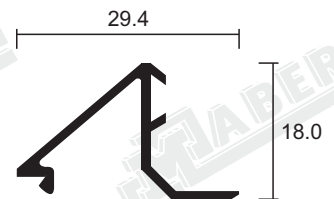

**ALN-414**

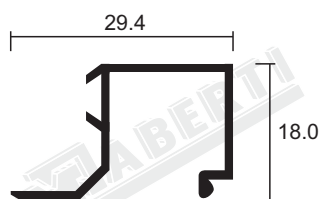

**ALN-481**

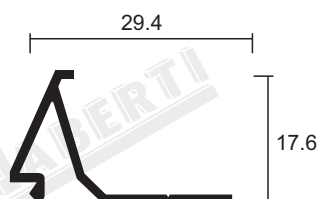

**CORTE HORIZONTAL**

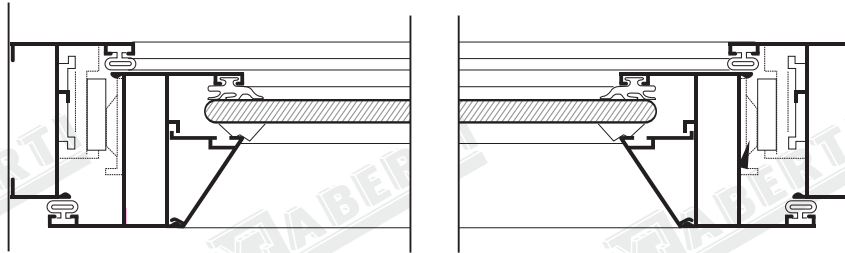

**CORTE VERTICAL**

**INTERIOR**

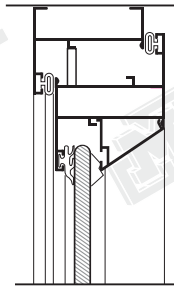

**EXTERIOR**

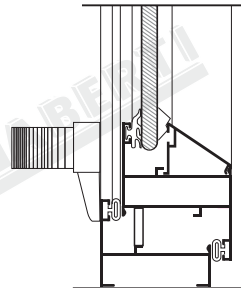

PERFIL							
CÓDIGO	ALN-4204	ALN-4209	ALN-4202	ALN-4203	ALN-4206	ALN-4208	ALN-4225
USO	Palillo	Marco fijo	Hoja	Junquillo	Junquillo doble vidrio	Junquillo	Hoja móvil

# SERIE 42 - VENTANA PROYECTANTE

**ALN-4204**

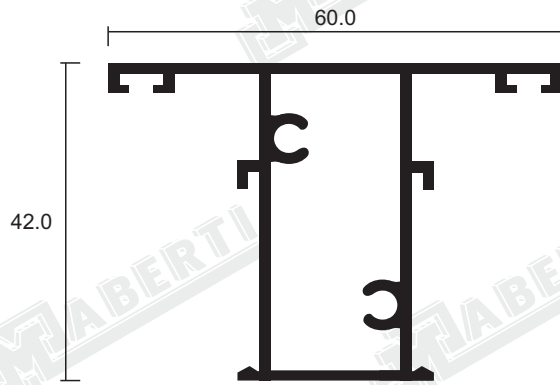

**ALN-4209**

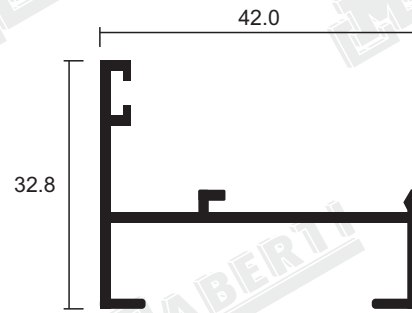

**ALN-4202**

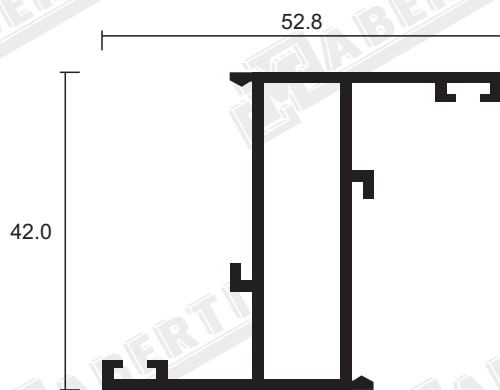

**ALN-4206**

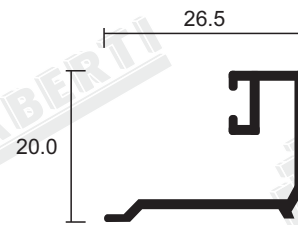

**ALN-4208**

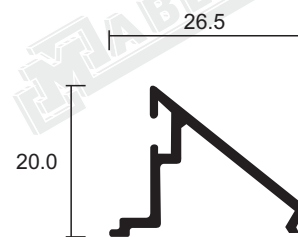

**ALN-4225**

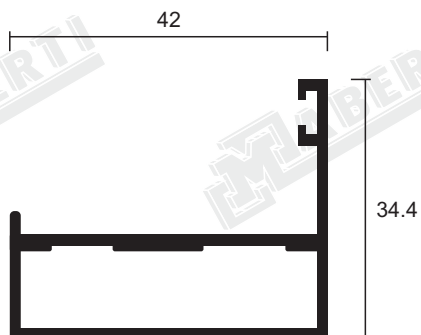

**ALN-4203**

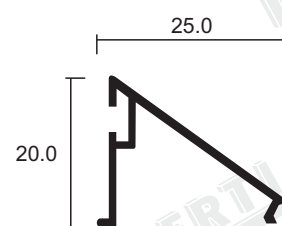

# SERIE 35 - PUERTA y/o VENTANA BATIENTE

## CORTE HORIZONTAL

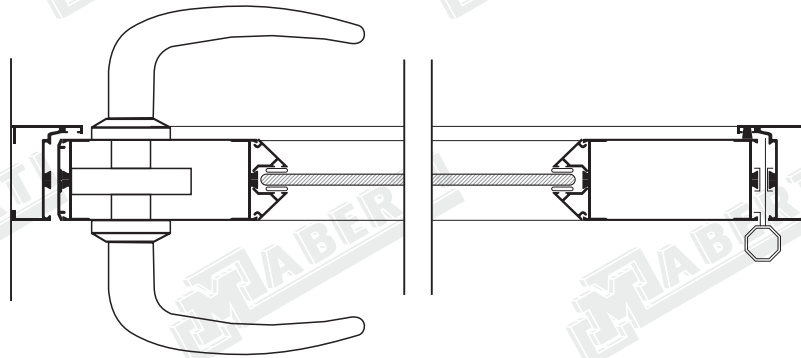

## CORTE VERTICAL

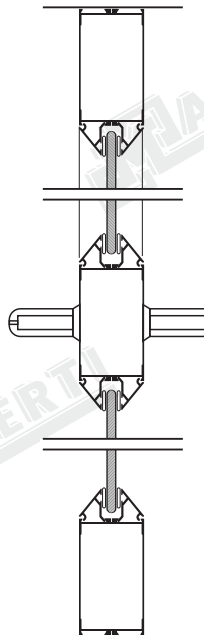

PERFIL								
CÓDIGO	ALN-3501	ALN-3502	ALN-3503	ALN-3506	ALN-3507	ALN-3508	ALN-3509	ALN-3510
USO	Bastidor	Marco	Junquillo	Tapa	Tapa portafelpa	Bastidor	Tope con portafelpa	Soporte de armado

# SERIE 35 - PUERTA y/o VENTANA BATIENTE

**ALN-3501**

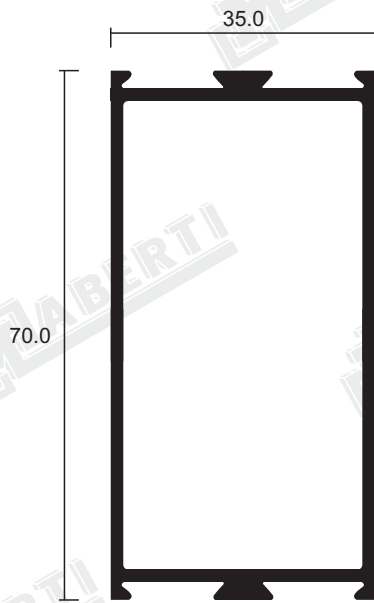

**ALN-3509**

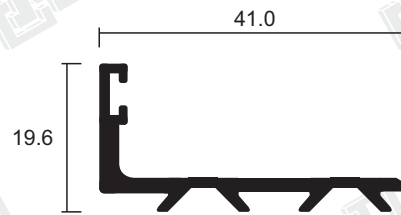

**ALN-3506**

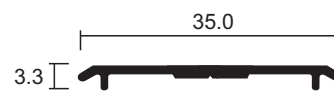

**ALN-3507**

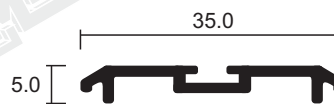

**ALN-3508**

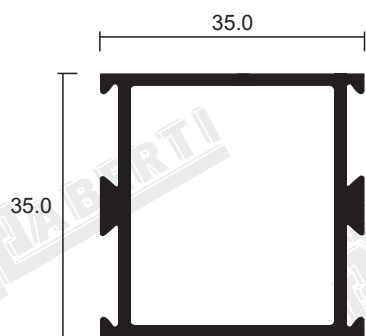

**ALN-3510**

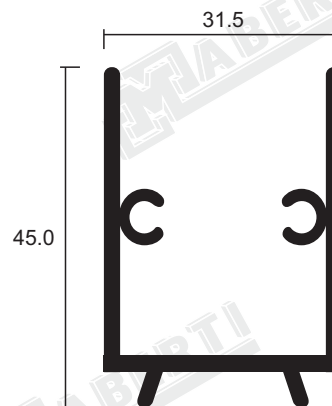

**ALN-3502**

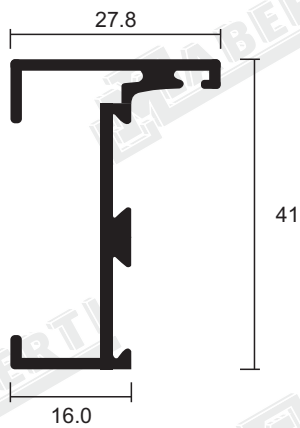

**ALN-3503**

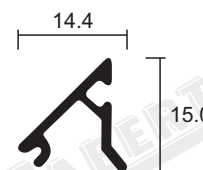

# SERIE 3142 - VENTANA CORREDIZA SUPERIOR

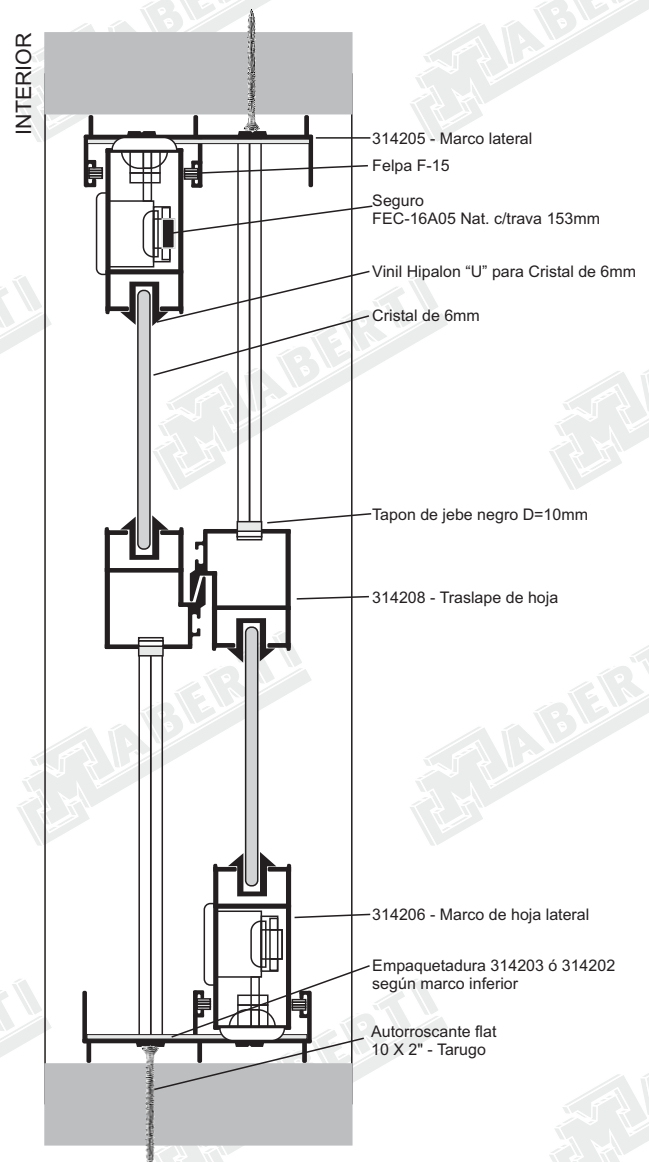
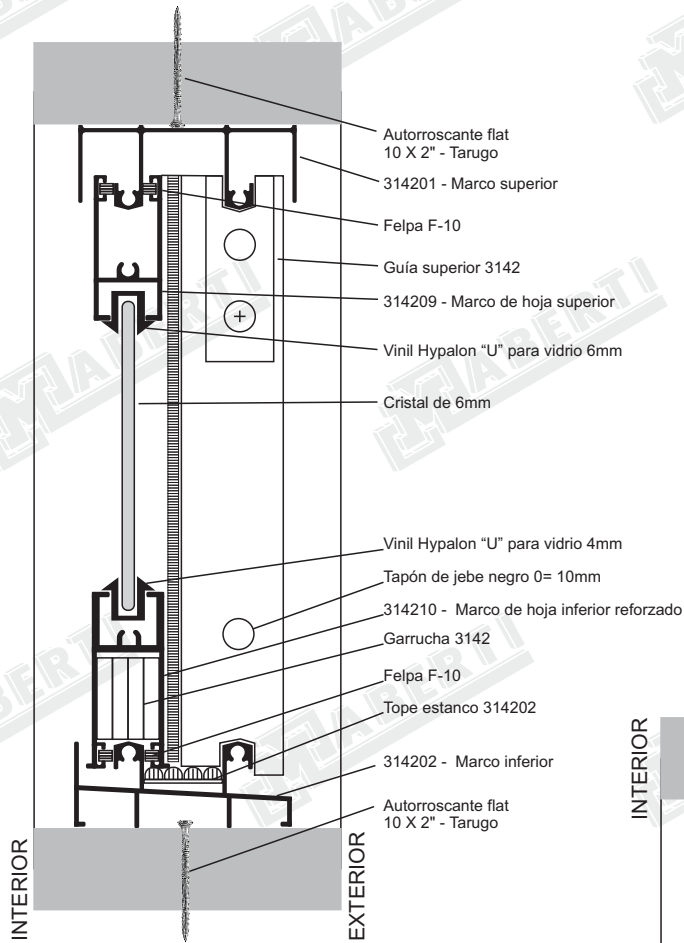



# SERIE 3142 - VENTANA CORREDIZA SUPERIOR

314201-MARCO SUPERIOR

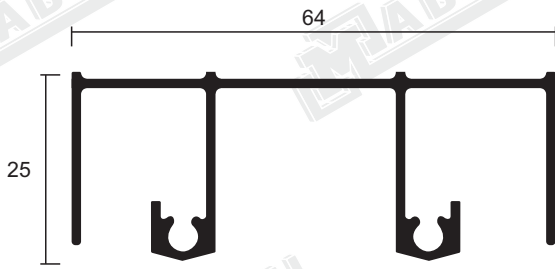

314202-MARCO INFERIOR

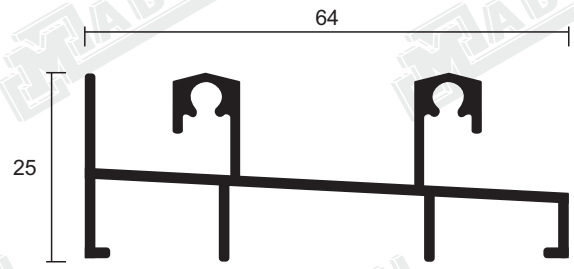

314205-MARCO LATERAL

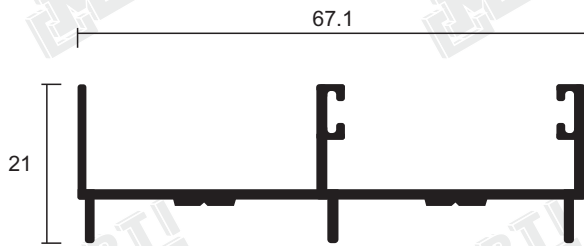

314208-TRASLAPÉ DE HOJA

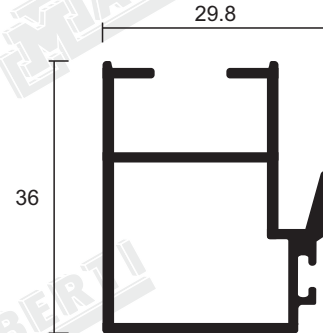

314209-MARCO DE HOJA SUPERIOR

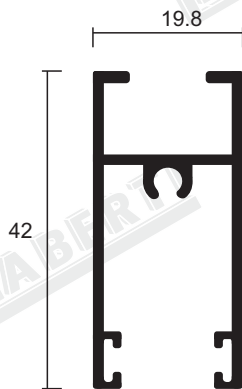

314206-MARCO DE HOJA LATERAL

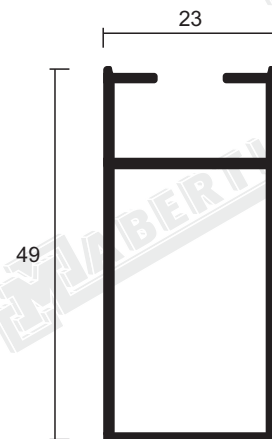

314210-MARCO DE HOJA REFORZADO

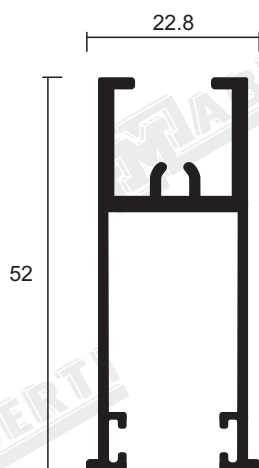

314211-ADAPTADOR DE HOJA

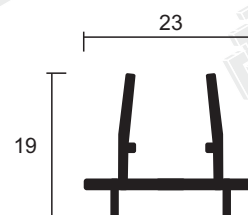

# SERIE 3642 - MAMPARA CORREDIZA SUPERIOR

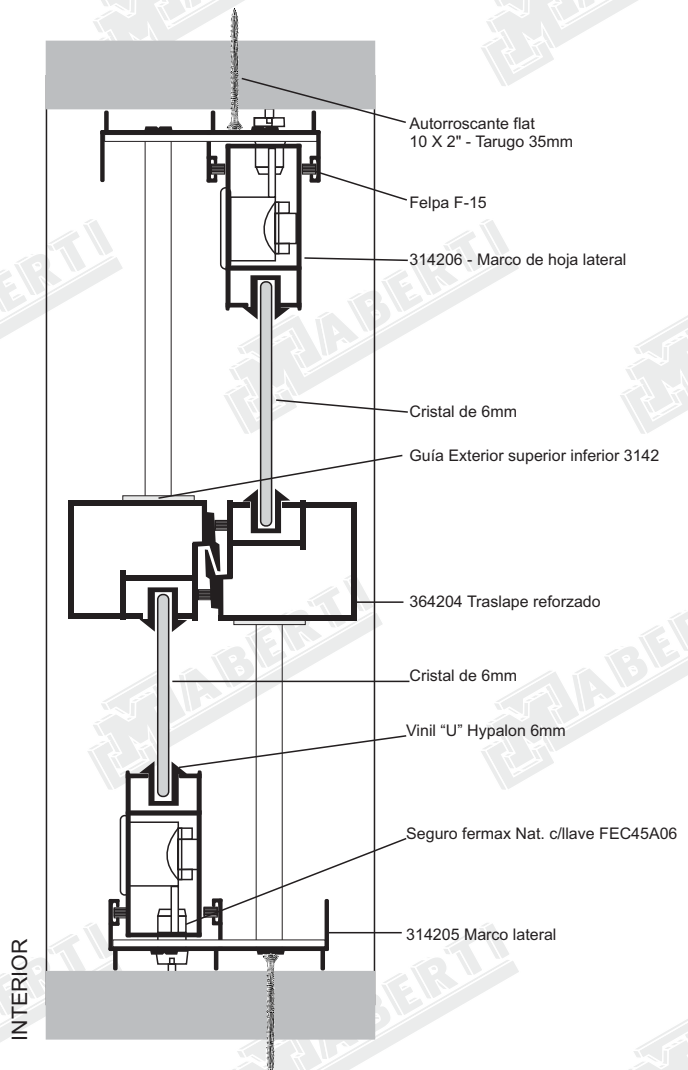
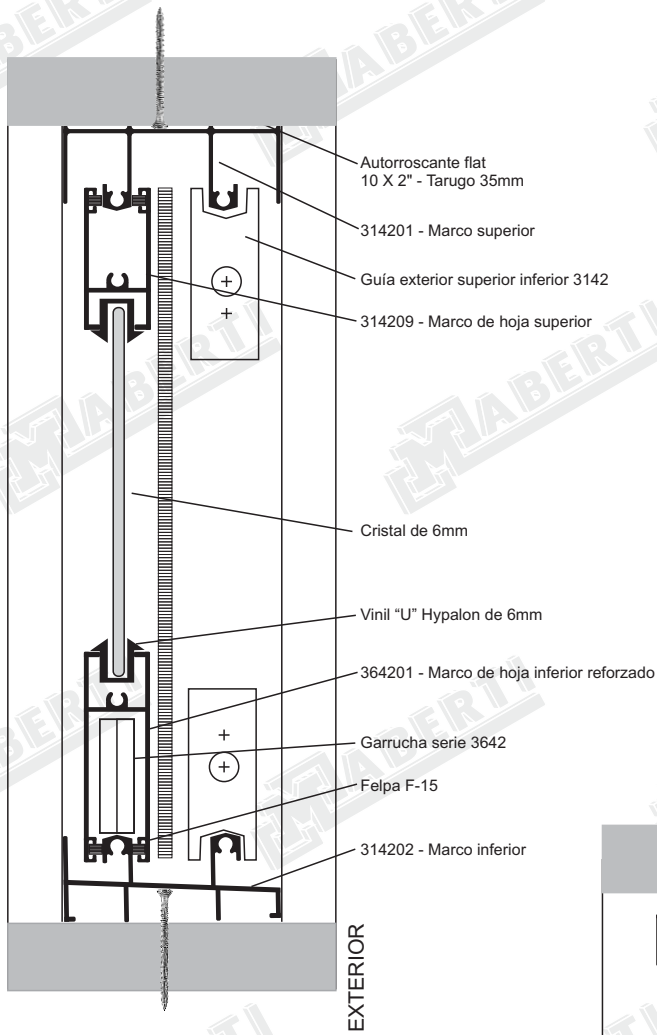

# SERIE 3642 - MAMPARA CORREDIZA SUPERIOR

**364201- MARCO DE HOJA  
INFERIOR REFORZADA**

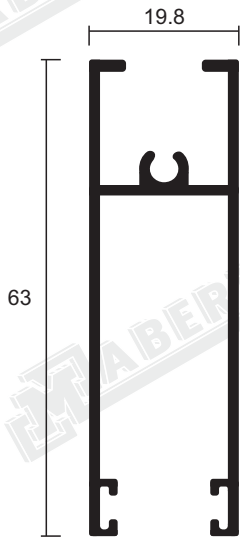

**314209- MARCO DE HOJA  
SUPERIOR**

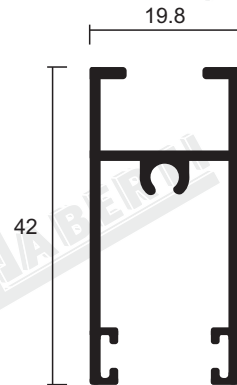

**314206- MARCO DE HOJA  
LATERAL**

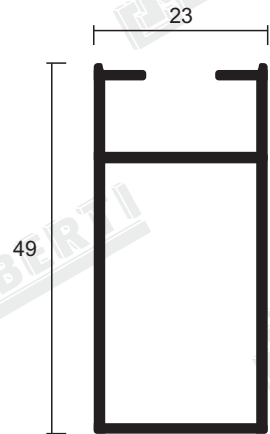

**314208- TRASLAPE DE HOJA**

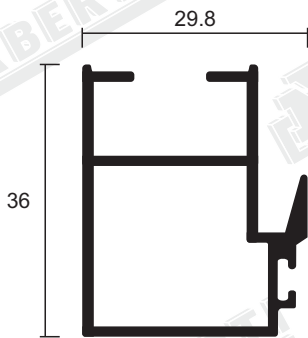

**323601- MARCO**

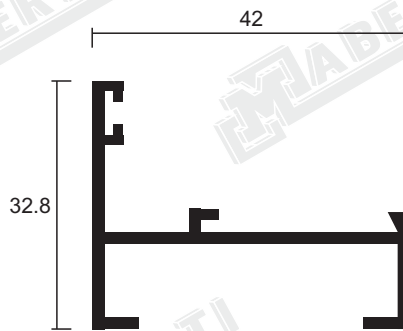

**314211-ADAPTADOR  
DE HOJA**

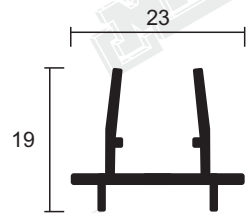

**323603-TRAVESAÑO**

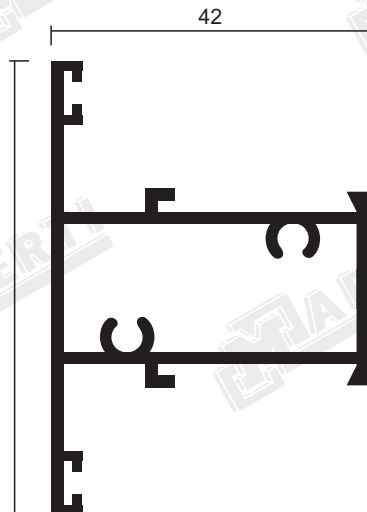

**314205-MARCO LATERAL**

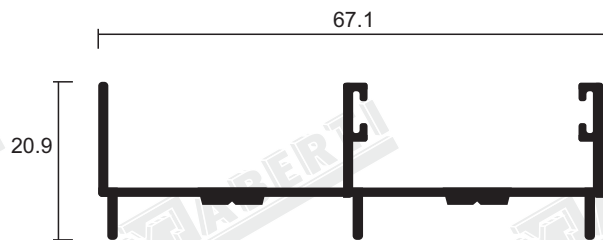

**042107-RIEL INFERIOR**



**323604-JUNQUILLO**

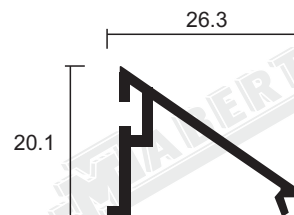

## ACRÍLICOS

Planchas decorativas de superficie traslúcida, ideales para separar los ambientes de cuarto de baño, vienen en variados colores y diseños brindan privacidad en los espacios sin perder luz natural además de ser resistentes y durables en el tiempo. Descripción

### MODELOS

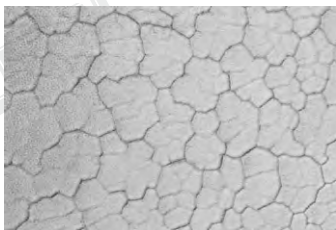

ESPUMA

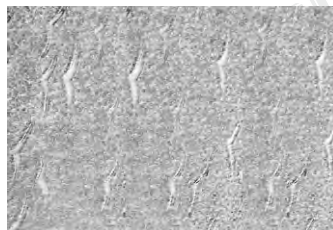

GAVIOTA



HIELO

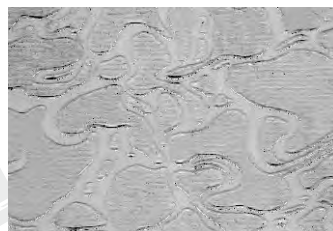

AMAZONAS



ESMERILADO

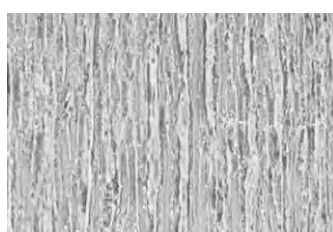

NIAGARA

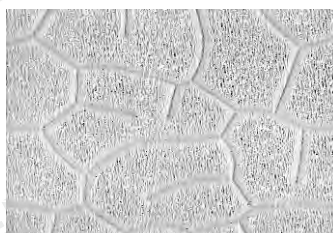

ARABESCO

### COLORES

■ Cristal   ■ Salmón   ■ Champagne   ■ Azul   ■ verde

### MEDIDAS

■ 1.80 M. x 0.80 M.   ■ 1.80 M. x 1.20 M.

## Instalación de las planchas

Las planchas se entregan con film de polipropileno adherido en ambas caras para protección. La cara que tiene el film con las impresiones es la que contiene la protección ultravioleta y debe ser removida inmediatamente después que se termina la instalación.

Efectúe los cortes con una sierra eléctrica ó con un cuchillo de mano, NO remueva los films de protección durante el proceso de corte.

Instale las planchas con las celdas de inclinación para permitir la caída del agua.

Instale las planchas con la cara protegida contra rayos UV (lado cubierto por protector señalizado) hacia el sol.

Advertencia: Si están instaladas de forma incorrecta no se aplica la garantía y pueden sufrir decoloración.

Los agujeros para colocar los tornillos en la plancha deben ser perforados con 2mm más de diámetro para permitir la expansión. Se recomienda utilizar huacha plana.

Las celdas expuestas deben ser cubiertas por la cinta permeable y conector terminal "U" para evitar el ingreso de agua y polvo.

Las uniones de las planchas se realizan con el perfil base/tapa ó el perfil "H" fijándose a la estructura con tornillos.

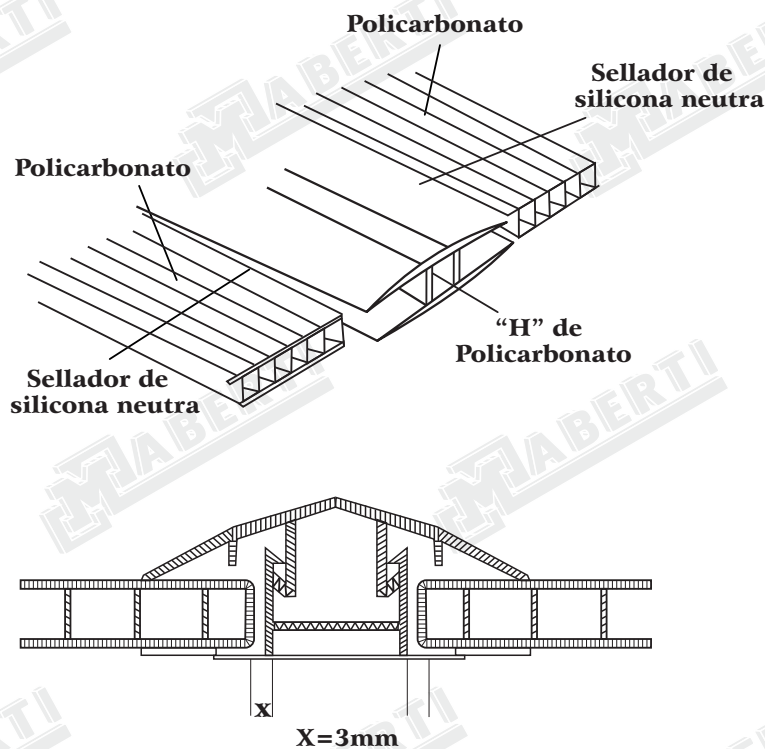

## Almacenamiento y mantenimiento

Almacénelas alejadas de los rayos solares y en un lugar con buena ventilación.

Para la limpieza, utilice agua y jabón. Evite abrasivos que puedan rayar la superficie.

La contaminación causada por soluciones químicas, debe de ser limpiada con alcohol y un paño suave, caso contrario pueden causar manchas o rupturas.

El polvo y suciedad deben ser limpiados con un paño y detergente neutro y secados con un paño limpio de algodón u otro material suave.

El suelo húmedo, ácido o alcalino puede causar daños.

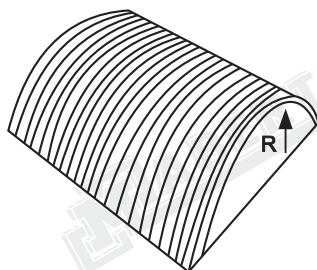

Espesor mm	Radio mínimo mm
4	700
6	1050
8	1400
10	1750

## Especificaciones del producto alveolar

Color	Propiedades			
	Transmisión de luz		Transmisión de calor	
	6mm	8mm	6mm	8mm
Blanco	33	28	0.30	0.11
Transparente	87	81	60.31	59.27
Verde	33	33	35.56	35.56
Azul	26	26	37.16	37.16
Bronce	19	19	28.51	28.51
Turquesa	47	40	44.39	38.41
Gris Reflectivo	20	18	7.25	3.37

Los colores Rojo, Naranja y Oro Reflectivo también están disponibles.

Espesor mm	Ancho mts	Largo mts
4	2.10	5.90
6	2.10	5.90 - 11.80
8	2.10	11.80
10	2.10	11.80